

VERSYS 650 ABS

Motorcycle

OWNER'S MANUAL

 **Read this manual carefully. It contains safety information.**

Kawasaki

Quick Reference Guide

This Quick Reference Guide will assist you in finding the information you're looking for.

SAFETY INFORMATION

GENERAL INFORMATION

HOW TO RIDE THE MOTORCYCLE

MAINTENANCE AND ADJUSTMENT

APPENDIX

MAINTENANCE RECORD

A Table of Contents is included after the Foreword.

Whenever you see the symbols shown below, heed their instructions! Always follow safe operating and maintenance practices.

 **DANGER**

DANGER indicates a hazardous situation which, if not avoided, will result in death or serious injury.

 **WARNING**

WARNING indicates a hazardous situation which, if not avoided, could result in death or serious injury.

NOTICE

NOTICE is used to address practices not related to personal injury.

NOTE

○ *NOTE* indicates information that may help or guide you in the operation or service of the vehicle.

 **WARNING**

Engine exhaust, some of its constituents, and certain vehicle components contain or emit chemicals known to the State of California to cause cancer and birth defects or other reproductive harm.

NOTICE

THIS PRODUCT HAS BEEN MANUFACTURED FOR USE IN A REASONABLE AND PRUDENT MANNER BY A QUALIFIED OPERATOR AND AS A VEHICLE ONLY.

Foreword

Congratulations on your purchase of a new Kawasaki motorcycle. Your new motorcycle is the product of Kawasaki's advanced engineering, exhaustive testing, and continuous striving for superior reliability, safety and performance.

Please read this Owner's Manual carefully before riding so that you will be thoroughly familiar with the proper operation of your motorcycle's controls, its features, capabilities, and limitations. This manual offers many safe riding tips, but its purpose is not to provide instruction in all the techniques and skills required to ride a motorcycle safely. Kawasaki strongly recommends that all operators of this vehicle enroll in a motorcycle rider training program to attain awareness of the mental and physical requirements necessary for safe motorcycle operation.

To ensure a long, trouble-free life for your motorcycle, give it the proper care and maintenance described in this manual. For those who would like more detailed information on their Kawasaki Motorcycle, a Service Manual is available for purchase from any authorized Kawasaki motorcycle dealer. The Service Manual contains detailed disassembly and maintenance information. Those who plan to do their own work should, of course, be competent mechanics and possess the special tools described in the Service Manual.

Keep this Owner's Manual aboard your motorcycle at all times so that you can refer to it whenever you need information.

This manual should be considered a permanent part of the motorcycle and should remain with the motorcycle when it is sold.

All rights reserved. No part of this publication may be reproduced without our prior written permission.

This publication includes the latest information available at the time of printing. However, there may be minor differences between the actual product and illustrations and text in this manual.

All products are subject to change without prior notice or obligation.

KAWASAKI HEAVY INDUSTRIES, LTD.
Motorcycle & Engine Company

© 2015 Kawasaki Heavy Industries, Ltd.

Apr. 14, 2015. (1)

Emission Control Information

To protect the environment in which we all live, Kawasaki has incorporated crankcase emission (1) and exhaust emission (2) control systems in compliance with applicable regulations of the United States Environmental Protection Agency and California Air Resources Board. Additionally, Kawasaki has incorporated an evaporative emission control system (3) in compliance with applicable regulations of the United States Environmental Protection Agency and California Air Resources Board.

1. Crankcase Emission Control System

This system eliminates the release of crankcase vapors into the atmosphere. Instead, the vapors are routed through an oil separator to the intake side of the engine. While the engine is operating, the vapors are drawn into the combustion chamber, where they are burned along with the fuel and air supplied by the fuel injection system.

2. Exhaust Emission Control System

This system reduces the amount of pollutants discharged into the atmosphere by the exhaust of this motorcycle. The fuel, ignition and exhaust systems of this motorcycle have been carefully designed and constructed to ensure an efficient engine with low exhaust pollutant levels. The exhaust system of this model motorcycle includes a catalytic converter system.

3. Evaporative Emission Control System

The evaporative emission control system for this vehicle consists of low permeation fuel hoses and fuel tank.

3. Evaporative Emission Control System (California)

Vapors caused by fuel evaporation in the fuel system are not vented into the atmosphere. Instead, fuel vapors are routed into the running engine to be burned, or stored in a canister when the engine is stopped.

High Altitude Performance Adjustment Information

High Altitude adjustment is not required.

Maintenance and Warranty

Proper maintenance is necessary to ensure that your motorcycle will continue to have low emission levels. This Owner's Manual contains those maintenance recommendations for your motorcycle. Those items identified by the Periodic Maintenance Chart are necessary to ensure compliance with the applicable standards.

As the owner of this motorcycle, you have the responsibility to make sure that the recommended maintenance is carried out according to the instructions in this Owner's Manual at your own expense.

The Kawasaki Limited Emission Control System Warranty requires that you return your motorcycle to an authorized Kawasaki dealer for remedy under warranty. Please read the warranty carefully, and keep it valid by complying with the owner's obligations it contains.

You should keep a maintenance record for your motorcycle. To assist you in keeping this record, we have provided space on pages 170 through 175 of this manual where an authorized Kawasaki dealer, or someone equally competent, can record the maintenance. You should also retain copies of maintenance work orders, bills, etc., as verification of this maintenance.

Tampering With Noise Control System Prohibited

Federal law prohibits the following acts or the causing thereof: (1) the removal or rendering inoperative by any person other than for purposes of maintenance, repair, or replacement, of any device or element of design incorporated into any new vehicle for the purpose of noise control prior to its sale or delivery to the ultimate purchaser or while it is in use, or (2) the use of the vehicle after such device or element of design has been removed or rendered inoperative by any person.

Among those acts presumed to constitute tampering are the acts listed below:

- * Replacement of the original exhaust system or muffler with a component not in compliance with Federal regulations.
- * Removal of the muffler(s) or any internal portion of the muffler(s).
- * Removal of the air box or air box cover.
- * Modifications to the muffler(s) or air intake system by cutting, drilling, or other means if such modifications result in increased noise levels.

TABLE OF CONTENTS

SAFETY INFORMATION	13	GENERAL INFORMATION	24
Read Owner's Manual	13	Specifications	24
Training	13	Serial Number Locations	28
Daily Checks and Periodic Maintenance	13	Location of Labels	29
Loading and Accessories Information	14	Location of Parts	37
Passenger	15	Meter Instruments	40
Baggage and Luggage	16	Indicators	41
Accessories	16	Speedometer/Tachometer	48
Other Load	17	Display Setting	49
If You are Involved in an Accident....	18	Clock	53
Safe Operation	18	Features	54
Carbon Monoxide Hazard	18	Keys	56
Fueling	19	Ignition Switch/Steering Lock	56
Never Ride with Drugs or Alcohol.	19	Right Handlebar Switches	58
Protective Gear and Clothing	19	Left Handlebar Switches	59
Safe Riding Techniques	20	Brake Lever Adjuster	60
Additional Considerations for High Speed Operation	22	Clutch Lever Adjuster	61
		Fuel	62
		Fuel Requirements	62
		Filling the Tank	65

Side Stand	67	Periodic Maintenance.....	97
Seat.....	68	Engine Oil	102
Tool Kit	69	Coolant.....	106
Rear View Mirrors	69	Air Cleaner	114
Windshield.....	70	Throttle Control System	115
Tie Hooks	71	Idle Speed	118
Helmet Hooks.....	71	Clutch.....	119
Event Data Recorder.....	72	Drive Chain	120
Electric Accessory Connectors	73	Brakes	125
HOW TO RIDE THE MOTORCYCLE	76	Brake Light Switches.....	127
Break-In	76	Suspension System	129
Starting the Engine	77	Front Fork	129
Jump Starting	80	Rear Shock Absorber	131
Moving Off.....	82	Setting Tables	133
Shifting Gears	83	Wheels	136
Braking	85	Battery.....	139
Anti-lock Brake System (ABS)	86	Headlight.....	143
Stopping the Engine.....	88	Fuses	144
Stopping the Motorcycle in an		General Lubrication.....	148
Emergency	89	Cleaning.....	149
Parking.....	90	General Precautions.....	149
MAINTENANCE AND ADJUSTMENT	92	Where to be Careful	153
Daily Checks	94	Washing Your Vehicle.....	154

APPENDIX	156
Storage	156
Troubleshooting Guide.....	159
Your Warranty/Owner Satisfaction ...	164

Reporting Safety Defects	169
Environmental Protection.....	170
MAINTENANCE RECORD	171

SAFETY INFORMATION

Read Owner's Manual

Read this Owner's Manual carefully before riding so that you will be thoroughly familiar with the proper operation of your motorcycle's controls, its features, capabilities, and limitations. This manual offers many safe riding tips, but its purpose is not to provide instruction in all of the techniques and skills required to ride a motorcycle safely.

Training

Kawasaki strongly recommends that all operators of this vehicle complete a suitable motorcycle rider training program to learn the proper skills and techniques necessary for safe motorcycle operation.

Daily Checks and Periodic Maintenance

It is important to keep your motorcycle properly maintained and in safe riding condition. Inspect your motorcycle before every ride and carry out all periodic maintenance. See the Daily Checks section and the Periodic Maintenance section in the MAINTENANCE AND ADJUSTMENT chapter for more information.

 **WARNING**

Failure to perform these checks or to correct a problem before operation may result in serious damage or an accident. Always perform daily checks before operation.

14 SAFETY INFORMATION

To ensure your motorcycle is serviced using the latest servicing information, it is recommended that an authorized Kawasaki Dealer performs the periodic maintenance as directed in the Owner's Manual.

If you notice any irregular operating condition, have your motorcycle thoroughly checked at an authorized Kawasaki dealer as soon as possible.

Loading and Accessories Information

WARNING

Incorrect loading, improper installation or use of accessories, or modification of your motorcycle may result in an unsafe riding condition. Before you ride the motorcycle, make sure it is not overloaded and that you have followed these instructions.

Maximum Load

Weight of rider, passenger, baggage, and accessories must not exceed 210 kg (463 lb).

With the exception of genuine Kawasaki Parts and Accessories, Kawasaki has no control over the design or application of accessories. In some cases, improper installation

or use of accessories, or motorcycle modification, will void the motorcycle warranty; can negatively affect performance, stability and safety; and can even be illegal.

In selecting and using accessories, and in loading the motorcycle, you are personally responsible for your own safety and the safety of other persons involved.

NOTE

○ *Kawasaki Parts and Accessories have been specially designed for use on Kawasaki motorcycles. We strongly recommend that all parts and accessories you add to your motorcycle be genuine Kawasaki components.*

Because a motorcycle is sensitive to changes in weight and aerodynamic forces, you must take extreme care in carrying cargo, passengers and/or in

fitting additional accessories. The following general guidelines have been prepared to assist you in making your determinations.

Passenger

1. Never carry more than one passenger.
2. The passenger should only sit on the pillion.
3. Any passenger should be thoroughly familiar with motorcycle operation. The passenger can affect control of the motorcycle by improper positioning during cornering and sudden movements. It is important that the passenger sits still while the motorcycle is in motion and not interfere with the operation of the motorcycle. Do not carry animals on your motorcycle.

16 SAFETY INFORMATION

4. Do not carry passengers unless passenger footpegs are installed. Instruct any passenger before riding to keep his or her feet on the passenger footpegs and hold on to the operator or grab rail. Do not carry a passenger unless he or she is tall enough to reach the footpegs with their feet.

Baggage and Luggage

1. All baggage should be carried as low as possible to reduce the effect on the motorcycle's center of gravity. Baggage weight should also be distributed equally on both sides of the motorcycle. Avoid carrying baggage that extends beyond the rear of the motorcycle.
2. Baggage should be securely attached. Make sure that the baggage

will not move around while you are riding. Recheck baggage security as often as possible (not while the motorcycle is in motion) and adjust as necessary.

3. Do not carry heavy or bulky items on a luggage rack. It is designed for light items, and overloading can affect handling due to changes in weight distribution and aerodynamic forces.

Accessories

1. Do not install accessories or carry baggage that impairs the performance of the motorcycle. Make sure that you have not adversely affected any lighting components, road clearance, banking capability (i.e., lean angle), control operation, wheel travel, front fork movement,

or any other aspects of the motorcycle's operation.

2. Weight attached to the handlebars or front fork will increase the mass of the steering assembly and can result in an unsafe riding condition.
3. Fairings, windshields, backrests, and other large items have the capability of adversely affecting stability and handling of the motorcycle, not only due to their weight, but also due to the aerodynamic force acting on these surfaces while the motorcycle is in operation. Poorly designed or installed items can result in an unsafe riding condition. Lugs are provided on the swingarm to attach accessory rear stand adapters. Always remove the rear stand adapters before riding or sitting on the machine to prevent possible damage to the muffler or swingarm.

Other Load

1. This motorcycle is not intended to be equipped with a sidecar or to be used to tow any trailers or other vehicles. Kawasaki does not manufacture sidecars or trailers for motorcycles and cannot predict the effects of such accessories on handling or stability, but can only warn that the effects can be adverse and that Kawasaki cannot assume responsibility for the results of such unintended use of the motorcycle.
2. Furthermore, any adverse effects on motorcycle components caused by the use of such accessories will not be remedied under warranty.

If You are Involved in an Accident

Make sure of your own safety first. Determine the severity of any injuries and call for emergency assistance if needed. Always follow applicable laws and regulations if any other person, vehicle or property is involved.

Do not attempt to continue riding without first evaluating your motorcycle's condition. Inspect for fluid leaks, check critical nuts and bolts, and check the handlebars, control levers, brakes, and wheels for damage and proper function. Ride slowly and cautiously - your motorcycle may have suffered damage that is not immediately apparent. Have your motorcycle thoroughly checked at a Kawasaki dealer as soon as possible.

Safe Operation

The following should be carefully observed for safe and effective vehicle operation.

Carbon Monoxide Hazard

DANGER

Exhaust gas contains carbon monoxide, a colorless, odorless poisonous gas. Inhaling carbon monoxide can cause serious brain injury or death. DO NOT run the engine in enclosed areas. Operate only in a well-ventilated area.

Fueling

 **WARNING**

Gasoline is extremely flammable and can be explosive under certain conditions. To avoid a possible fire or explosion, turn the ignition switch off. Do not smoke. Make sure the area is well ventilated and free from any source of flame or sparks; this includes any appliance with a pilot light.

Never Ride with Drugs or Alcohol

Alcohol and drugs impair your judgment and reaction time. Never consume alcohol or drugs before or while riding motorcycles.

Protective Gear and Clothing

Helmet

Kawasaki strongly recommends both the operator and passenger wear a DOT-approved helmet even if this is not a legal requirement.

- Make sure that your helmet fits correctly and is properly fastened.
- Choose a motorcycle helmet that meets DOT safety standards. Ask your motorcycle dealer to advise you if necessary.

20 SAFETY INFORMATION

Eye Protection

Always use eye protection. If your helmet does not have a visor installed, wear goggles.

Gloves

Wear gloves which have suitable protection for your hands, especially against abrasion.

Clothing

Wear protective clothing.

- Wear bright, highly visible clothing that allows freedom of movement to suit your riding style.
- Always wear a long- sleeved jacket and long trousers which are abrasion resistant and keep you warm.
- Avoid wearing clothes which have loose cuffs or other fastenings which could interfere with the controls of your motorcycle.

Boots

Wear proper protective boots that fit properly and do not interfere with gear shifting or braking.

Safe Riding Techniques

Keep Hands on Handlebars

When riding always keep both hands on the handlebars and both feet on the footpegs. Removing your hands from the handlebars or feet from the footpegs while riding can be hazardous. If you remove even one hand or foot, you reduce your ability to control the motorcycle.

Look Over Your Shoulder

Before changing lanes, look over your shoulder to make sure the way is clear. Do not rely solely on the rear

view mirror; you may misjudge a vehicle's distance and speed, or you may not see it at all.

Accelerate and Brake Smoothly

In general your actions should be smooth as sudden acceleration, braking or turning may cause loss of control, especially when riding in wet conditions or on loose road surfaces, when the ability to maneuver will be reduced.

Select Correct Gear Speeds

When going up steep slopes, shift to a lower gear so that there is power to spare rather than overloading the engine.

Use Both Front and Rear Brakes

When applying the brakes, use both the front and rear brakes. Applying only one brake for sudden braking may cause the motorcycle to skid and lose control.

Use Engine Brake

When going down long slopes, help control vehicle speed by closing the throttle so that the engine can act as an auxiliary brake. Use the front and rear brakes for primary braking.

Riding in Wet Conditions

Rely more on the throttle to control vehicle speed and less on the front and rear brakes. The throttle should also be used judiciously to avoid skidding the rear wheel from too rapid acceleration or deceleration.

Braking performance is also reduced in wet conditions. Carefully ride at a slow speed and apply the brakes several times to help dry and restores them to normal operating performance.

Lubricate the drive chain after wet-weather riding to prevent rust and corrosion.

Ride Prudently

Riding at the proper speed and avoiding unnecessarily fast acceleration are important not only for safety and low fuel consumption but also for long vehicle life and quieter operation.

Riding on Rough Roads

Exercise caution, slow down, and grip the fuel tank with the knees for better stability.

Acceleration

When quick acceleration is necessary to pass another vehicle, shift to a lower gear to obtain the necessary power.

Downshifting

To avoid engine damage and rear wheel lock-up do not downshift at high rpm.

Avoid Unnecessary Weaving

Unnecessary weaving jeopardizes the safety of both the rider and other motorists.

Additional Considerations for High Speed Operation

 WARNING
--

<p>Handling characteristics of a motorcycle at high speeds may vary from those you are familiar with at legal highway speeds. Do not attempt high speed operation unless you have received sufficient training and have the required skills.</p> <p>Do not operate at high speeds on public roads.</p>
--

Brakes

The importance of the brakes, especially during high speed operation, cannot be overemphasized. Check to see that they are correctly adjusted and functioning properly.

Steering

Looseness in the steering can cause loss of control. Check to see that the handlebars turns freely but has no play.

Tires

High speed operation is hard on tires, and good tires are crucial for safe riding. Examine their overall condition, inflate them to the proper pressure, and check the wheel balance.

Fuel

Have sufficient fuel for the high fuel consumption during high speed operation.

Engine Oil

To avoid engine seizure and resulting loss of control, make sure that the oil level is at the upper level line.

Coolant

To avoid overheating, check that the coolant level is at the upper level line.

Electrical Equipment

Make sure that the headlight, tail/brake light, turn signals, horn, etc., all work properly.

Miscellaneous

Make sure that all nuts and bolts are tight and that all safety related parts are in good condition.

Specifications

PERFORMANCE

Minimum Turning Radius 2.7 m (106 in.)

DIMENSIONS

Overall Length 2 165 mm (85.24 in.)

Overall Width 840 mm (33.1 in.)

Overall Height/High Position 1 400 mm (55.12 in.)/1 450 mm (57.09 in.)

Wheelbase 1 415 mm (55.71 in.)

Road Clearance 170 mm (6.69 in.)

Curb Mass 216 kg (476 lb)

ENGINE

Type DOHC, 2-cylinder, 4-stroke, liquid-cooled

Displacement 649 cm³ (39.6 cu in.)

Bore × Stroke 83.0 × 60.0 mm (3.3 × 2.4 in.)

Compression Ratio 10.8:1

Starting System	Electric starter
Cylinder Numbering Method	Left to right, 1-2
Firing Order	1-2
Fuel System	FI (Fuel Injection)
Ignition System	Battery and coil (transistorized ignition)
Ignition Timing (Electronically advanced)	10° BTDC @1 300 r/min (rpm) ~ 56° BTDC @5 200 r/min (rpm)
Spark Plug:	Type NGK CR9EIA-9
	Gap 0.8 ~ 0.9 mm (0.031 ~ 0.035 in.)
Lubrication System	Forced lubrication (semi-dry sump)
Engine Oil:	Type API SG, SH, SJ, SL, or SM with JASO MA, MA1 or MA2
	Viscosity SAE 10W-40
	Capacity 2.3 L (2.4 US qt)
Coolant Capacity	1.2 L (1.3 US qt)

TRANSMISSION

Transmission Type	6-speed, constant mesh, return shift
Clutch Type	Wet, multi disc

26 GENERAL INFORMATION

Driving System		Chain drive
Primary Reduction Ratio		2.095 (88/42)
Final Reduction Ratio		3.067 (46/15)
Overall Drive Ratio		5.473 (Top gear)
Gear Ratio:	1st	2.438 (39/16)
	2nd	1.714 (36/21)
	3rd	1.333 (32/24)
	4th	1.111 (30/27)
	5th	0.966 (28/29)
	6th	0.852 (23/27)

FRAME

Caster		25°
Trail		108 mm (4.25 in.)
Tire Size:	Front	120/70ZR17 M/C (58W)
	Rear	160/60ZR17 M/C (69W)
Rim Size:	Front	J17M/C × MT3.50
	Rear	J17M/C × MT4.50

Fuel Tank Capacity		21 L (5.5 US gal)
Brake Fluid:	Front	DOT4
	Rear	DOT4

ELECTRICAL EQUIPMENT

Battery		12 V 10 Ah (10 HR)
Headlight:	High Beam	12 V 55 W
	Low Beam	12 V 55 W
Brake/Tail Light		LED

Even if one of LED (Light Emitting Diode) brake/tail light does not go on, consult with an authorized Kawasaki dealer.

Specifications are subject to change without notice.

Serial Number Locations

The engine and frame serial numbers are used to register the motorcycle. They are the only means of identifying your particular machine from others of the same model type. These serial numbers may be needed by your dealer when ordering parts. In the event of theft, the investigating authorities will require both numbers as well as the model type and any peculiar features of your machine that can help them identify it.

Engine No.

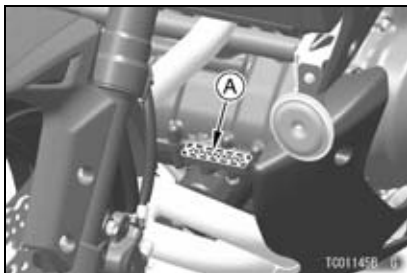

A. Engine Number

Frame No.



A. Frame Number

Location of Labels

All warning labels which are on your vehicle are repeated here. Read labels on your vehicle and understand them thoroughly. They contain information which is important for your safety and the safety of anyone else who may operate your vehicle. Therefore, it is very important that all warning labels be on your vehicle in the locations shown. If any label is missing, damaged, or worn, get a replacement from your Kawasaki dealer and install it in the correct position.

NOTE

- *The sample warning labels in this section have part numbers to help*

you and your dealer obtain the correct replacement.

- *Refer to the actual vehicle label for model specific data grayed out in the illustration.*

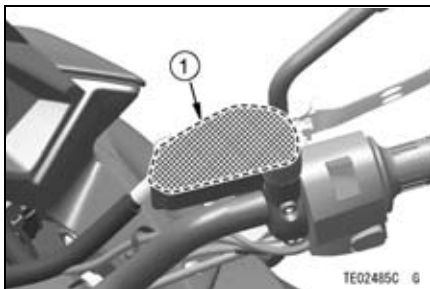

1. Brake Fluid (Front)

30 GENERAL INFORMATION

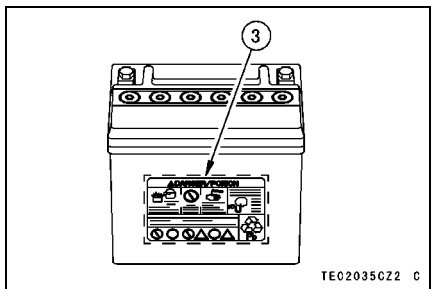
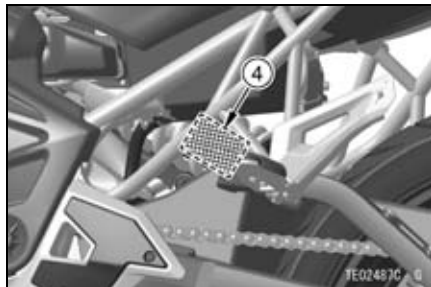

- 2. Brake Fluid (Rear)
- 3. Battery Poison/Danger
- 4. Rear Shock Absorber Warning

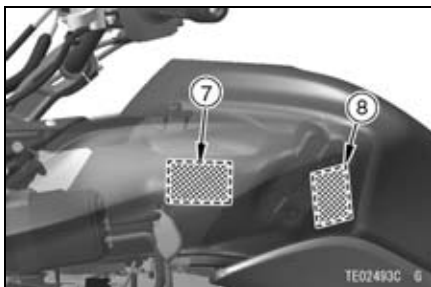
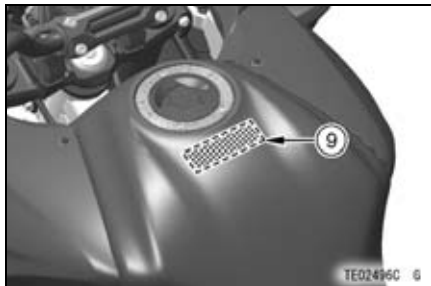
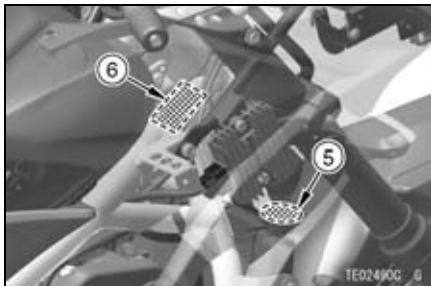

- 5. Radiator Cap Danger
- 6. Weight and Manufacture
- 7. Vehicle Emission Control Information
- *8. Vacuum hose Routing Diagram
- *9. Fuel Level

*: only on California model

32 GENERAL INFORMATION

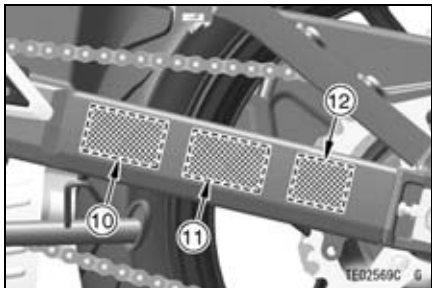

10. Tire and Load Data

11. Important Drive Chain Information

12. Noise Emission Control Information

1)

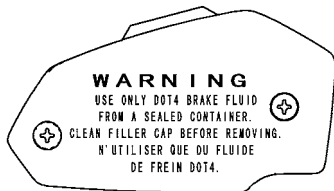

TE03841BN9 C

3)



TE03508D S

2)



TE03527D S

34 GENERAL INFORMATION

4)

▲ WARNING
This unit contains high pressure nitrogen gas. Mis-handling can cause explosion. ● Do not incinerate, puncture or open.
▲ AVERTISSEMENT
Cette unité contient de l'azote à haute pression. Une mauvaise manipulation peut entraîner d'explosion. ● Ne pas brûler ni perforer ni ouvrir.
▲ 警告
高压窒素ガス入りです。 取り扱いを誤ると爆発する恐れがあります。 ● 火中への投入、穴あけ、分解はしないでください。

TE03460DN7 C

5)



TE03079E S

6)

MFD. BY KAWASAKI HEAVY INDUSTRIES, LTD.	
DATE:	THIS VEHICLE CONFORMS
TO ALL APPLICABLE FEDERAL MOTOR VEHICLE	
SAFETY STANDARDS IN EFFECT ON THE DATE	
OF MANUFACTURE SHOWN ABOVE. GVWR	LBS.
GAWR F	LBS. WITH
TIRE,	RIM, AT PSI. GOLD.
GAWR R	LBS. WITH
TIRE,	RIM, AT PSI. GOLD.
MOTOR CYCLE	
MADE IN THAILAND	

TE03442DN9 C

7)

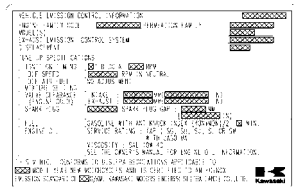

TE03510D S

7) only on California model

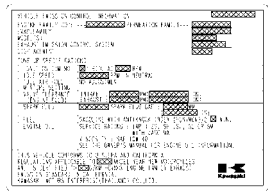

TE03511D S

8) only on California model

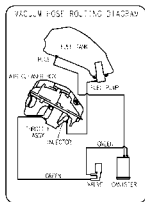

TE03187E S

9) only on California model



56071-0158

TE03142C S

36 GENERAL INFORMATION

10)

WARNING			
Use of tires with improper inflation or excessive wear, unsuitable replacement tires or overloading can result in a loss of control causing serious bodily injury. See Owner's Manual for additional information.			
TIRE AND LOAD DATA			
Front		Rear	
49-174 70 H 155 163 B 3	25 psi 1.75 kg/m ² (3.93 psi)	49-174 70 H 155 163 B 3	25 psi 1.75 kg/m ² (3.93 psi)
49-174 70 H 155 163 B 3		49-174 70 H 155 163 B 3	
49-174 70 H 155 163 B 3		49-174 70 H 155 163 B 3	

56053-1112

TE03383E S

12)

MOTORCYCLE NOISE EMISSION CONTROL INFO
THIS <input checked="" type="checkbox"/> MOTORCYCLE MEETS EPA NOISE EMISSION REQUIREMENTS BY THE FEDERAL TEST PROCEDURES. MODIFICATIONS WHICH CAUSE THIS MOTORCYCLE TO EXCEED FEDERAL NOISE STANDARDS ARE PROHIBITED BY FEDERAL LAW. SEE OWNER'S MANUAL.
MODEL SPECIFIC CODE: <input checked="" type="checkbox"/>
SEE VEHICLE IDENTIFICATION NUMBER ON STEERING HEAD
NOISE LIMIT/CLOSING RPM: <input checked="" type="checkbox"/> DBA / <input checked="" type="checkbox"/> RPM

TE03201E S

11)

CHAIN INFORMATION
Make chain slack checks be checked before each ride and adjusted if outside of normal adjustment range (75-85 mm (3.0-3.4 in)). To check, pull the upper link plate between the sprockets while the motorcycle is on the side stand. See Owner's Manual for additional chain information.

56033-0884

TE03369E S

Location of Parts

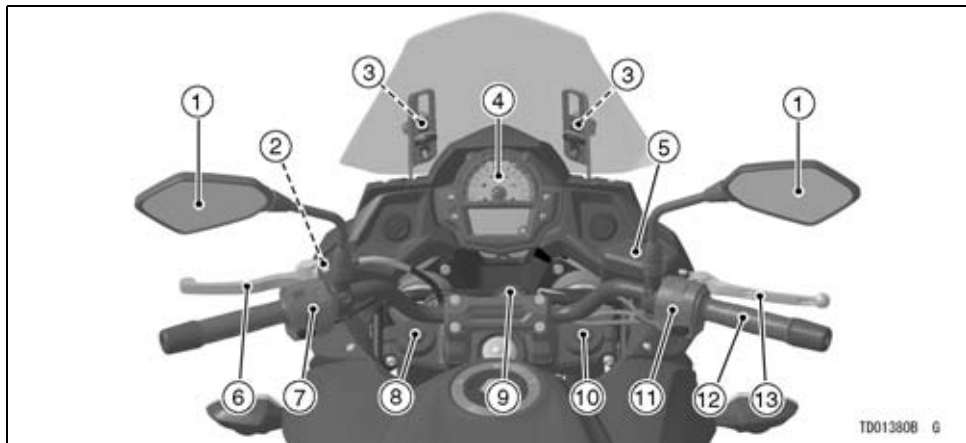

1. Rear View Mirrors
2. Starter Lockout Switch
3. Windshield Adjusting Knobs
4. Meter Instrument
5. Brake Fluid Reservoir (Front)
6. Clutch Lever
7. Left Handlebar Switches

8. Spring Preload Adjuster
9. Ignition Switch/Steering Lock
10. Rebound Damping Force Adjuster
11. Right Handlebar Switches
12. Throttle Grip
13. Front Brake Lever

38 GENERAL INFORMATION

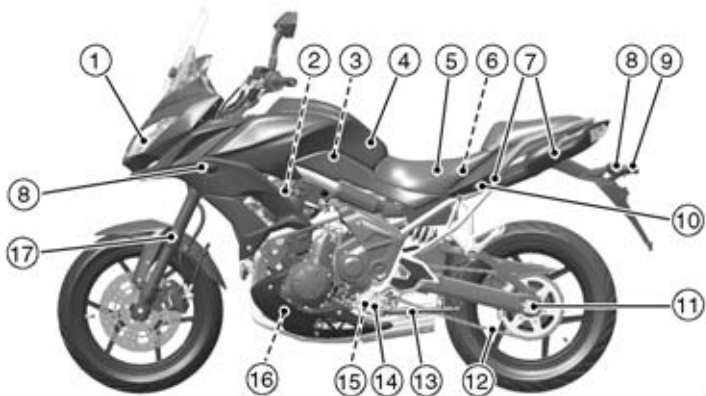

TD01381B G

- 1. Headlight
- 2. Spark Plugs
- 3. Air Cleaner
- 4. Fuel Tank
- 5. Seat
- 6. Helmet Hook

- 7. Tie Hooks
- 8. Turn Signal Lights
- 9. License Plate Light
- 10. Seat Lock
- 11. Chain Adjuster
- 12. Drive Chain

- 13. Side Stand
- 14. Shift Pedal
- 15. Side Stand Switch
- 16. Oil Filter
- 17. Front Fork

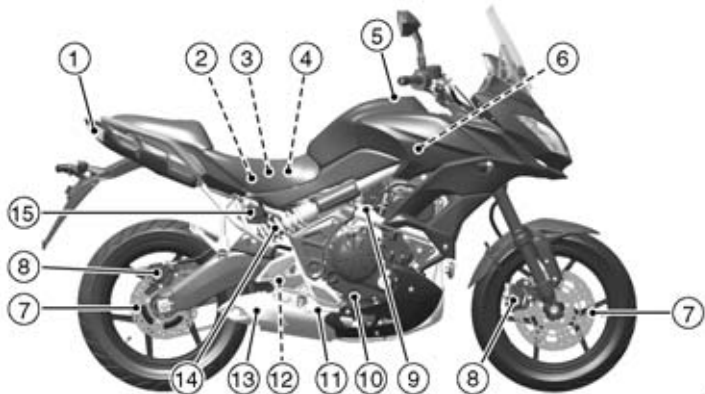

TD01382B G

- | | |
|---------------------------------|---------------------------------|
| 1. Tail/Brake Light | 9. Idle Adjusting Screw |
| 2. Brake Fluid Reservoir (Rear) | 10. Oil Level Inspection Window |
| 3. Fuse Boxes | 11. Rear Brake Pedal |
| 4. Battery | 12. Rear Brake Light Switch |
| 5. Fuel Tank Cap | 13. Muffler |
| 6. Coolant Reserve Tank | 14. Rear Shock Absorber |
| 7. Brake Discs | 15. Spring Preload Adjuster |
| 8. Brake Calipers | |

Meter Instruments

1. Tachometer
2. Left Meter Button
3. Right Meter Button
4. Multifunction Meter
5. Fuel Gauge
6. Economical Riding Indicator
7. Speedometer
8. Multifunction Display
 - Odometer
 - Trip Meter A/B
 - Current Mileage/Average Mileage/Cruising Range
9. Clock

When the ignition switch is turned on, all LCD functions are shown for a few seconds, then the multifunction meter turns to operational mode.

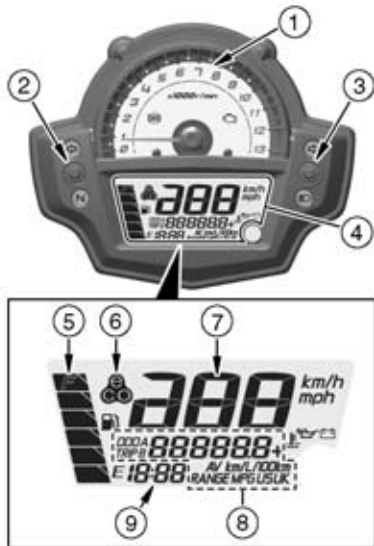

Indicators

1.  Left Turn Signal Indicator (Green)
2.  ABS Indicator (Yellow)
3.  Engine Warning Indicator (Yellow)
4.  Right Turn Signal Indicator (Green)
5.  High Beam Indicator (Blue)
6.  Battery Warning Indicator
7.  Oil Pressure Warning Indicator
8.  Warning Indicator (Red)
9.  Coolant Temperature Warning Indicator
10.  Fuel Level Warning Indicator
11.  Neutral Indicator (Green)



42 GENERAL INFORMATION

Indicator Initial Operation

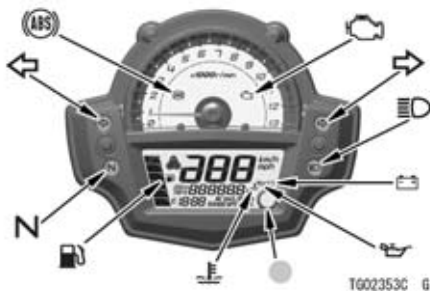

When the ignition switch is turned on, all indicators go on/off as shown in the table. If any indicator does not operate as shown, have it checked by an authorized Kawasaki dealer.

ON			Indicators		
<input type="checkbox"/>	<input type="checkbox"/>	<input type="checkbox"/>	N *		
<input type="checkbox"/>	<input type="checkbox"/>	<input checked="" type="checkbox"/>			
<input type="checkbox"/>	<input checked="" type="checkbox"/>	<input checked="" type="checkbox"/>			
<input checked="" type="checkbox"/>	<input checked="" type="checkbox"/>	<input checked="" type="checkbox"/>			

ON: When ignition switch is turned on.

: After a few seconds

: When engine starts.

: Goes on.





: Goes off.

* : goes off shortly after the motorcycle starts moving.



When Warning Indicators Go On or Blink



When warning indicators appear, there could be a problem with vehicle function. Follow actions in the table after stopping the vehicle in a safe place.

*: The numbers in this column corresponds to reference numbers on page 41.

*No.	Indicators	Status	Actions
2		ON* ¹	The ABS has malfunctioned. ABS will not work but conventional brakes function. Have the ABS checked by an authorized Kawasaki dealer.
3		ON	The DFI system has malfunctioned. Have it checked by an authorized Kawasaki dealer.
		Blink	If this indicator blinks while pushing the starter button, the vehicle-down sensor has been tripped and the engine cannot be started. Turn the ignition switch off and then back on to start the engine.
8 6	 	ON	These indicators go on if the battery voltage is less than 11.0 V or more than 16.0 V. If they go on, charge the battery. If they still go on after charging the battery, have the battery and/or charging system checked by an authorized Kawasaki dealer.

44 GENERAL INFORMATION

*No.	Indicators	Status	Actions
8 7		ON	These indicators go on whenever the oil pressure is dangerously low or the ignition switch is in the "ON" position with the engine not running. If these indicators go on when the engine speed is above idle, stop the engine immediately and check the engine oil level. If the amount of engine oil is insufficient, add engine oil. If the oil level is good, have the engine checked by an authorized Kawasaki dealer.
8 9		ON	These indicators go on whenever the coolant temperature rises to about 119°C (246°F). Refer to the Multifunction Display in the Display Setting section for more information and follow instructions in it.

*No.	Indicators	Status	Actions
10		Blink	The lowest segment and fuel level warning indicator blink in the multifunction display when approximately 5.6 L (1.5 US gal) of usable fuel remains. Refuel at the earliest opportunity. If the vehicle is on the side stand, the warning indicator cannot estimate the amount of fuel in the tank. Stand the vehicle upright to check the fuel level.
		Blink (including all segments)	The fuel level warning system has malfunctioned. Have the fuel level warning system checked by an authorized Kawasaki dealer.



46 GENERAL INFORMATION

*1: ABS indicator may go on:

- After continuous riding on a rough road.
- When the engine is started with the stand raised and the transmission engaged, and the rear wheel turns.
- When accelerating so abruptly that the front wheel leaves the ground.
- When the ABS has been subjected to strong electrical interference.
- When tire pressure is abnormal. Adjust tire pressure.
- When a tire different in size from the standard size is being used. Replace with standard size.
- When the wheel is deformed. Replace the wheel.

If this happens, first turn the ignition switch off, and then back on, and ride the motorcycle at 5 km/h (3.1 mph) or more. The ABS indicator should then go off. If it does not, have the ABS checked by an authorized Kawasaki dealer.

Other Indicators

*No.	Indicators	Status
1		When the turn signal switch is pushed to the left, this indicator blinks.
4		When the turn signal switch is pushed to the right, this indicator blinks.
5		When the headlight is on high beam, this indicator goes on.
11	N	When the transmission is in neutral, this indicator goes on.

Speedometer/Tachometer

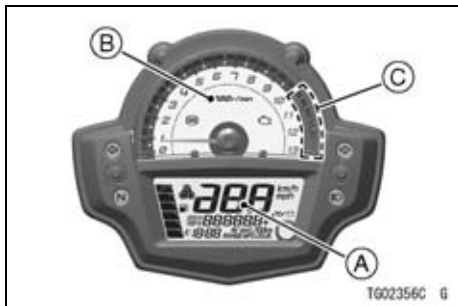

- A. Speedometer
- B. Tachometer
- C. Red Zone

Speedometer

The speedometer is digital and can be set for km/h or mph.

The unit setting can be changed according to local regulations. Make sure

the unit setting (km/h or mph) is correctly displayed before riding.

Refer to the Unit Setting in the Display Setting section.

Tachometer

The tachometer shows the engine speed in revolutions per minute (r/min, rpm).

NOTICE

Engine speed should not be allowed to enter the red zone; operation in the red zone will overstress the engine and may cause serious engine damage.

When the ignition switch is turned on, the tachometer needle momentarily sweeps from the minimum to the maximum reading, then back the minimum reading to check its operation. If

the tachometer does not operate correctly, have it checked by an authorized Kawasaki dealer.

Display Setting

Multifunction Display

 **WARNING**

For safety, do not operate the meter buttons while riding the motorcycle.

- Push the left meter button to select the display modes. The display modes can be shifted in the following order.

NOTE

- *The multifunction display is displayed in the unit depending on the unit mode setting.*
- *When the battery is reconnected, the meter display is set to odometer by default.*

50 GENERAL INFORMATION

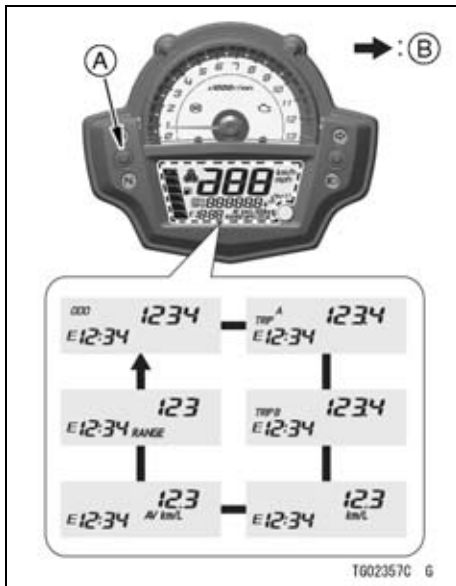

A. Left Meter Button

B. Flow when pushing left meter button

Odometer

The odometer shows the total distance. This meter cannot be reset.

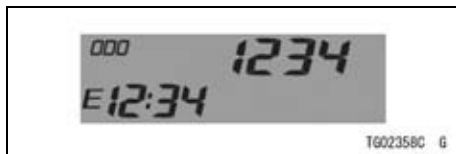

NOTE

○ When the figures come to 999999, the display is stopped and locked.

Trip Meter

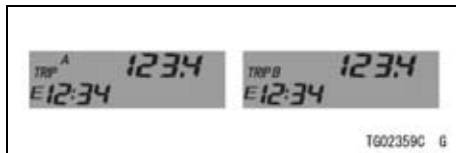

To reset the trip meter:

- Push the left meter button to select the trip meter A or B.

- Push the right meter button and hold it in until the display turns to 0.0.

NOTE

- *When the trip meter reaches 9999.9 while riding, the meter resets to 0.0 and continues counting.*

Current Mileage

The current mileage display is renewed every 4 seconds.



NOTE

- *When the ignition switch is turned on, the numerical value shows “- -.-.” After a few seconds of riding the numerical value is displayed.*

- *When the ignition switch is turned off, the current mileage resets to “0.0.”*

Average Mileage

This display mode shows the average fuel consumption from the reset. The average mileage display is renewed every 4 ~ 6 seconds.



To reset the average mileage:

- Push the right meter button and hold it in until the average mileage values resets to “- -.-.”

NOTE

- *When the battery is disconnected, the average mileage resets to “- -.-.”*

52 GENERAL INFORMATION

- *After resetting the average mileage, the numerical value is not displayed until the vehicle has travelled 100 m (328 ft).*

Cruising Range

This display shows the cruising range by numerical value, and indicates the cruising range from the remaining fuel in the fuel tank. This cruising range display is renewed every 20 seconds.



NOTE

- *The cruising range value is no longer shown if the fuel level gets too low after the fuel level warning indicator starts blinking.*
- *To recover the cruising range value display add fuel to at least the level needed for the fuel level warning indicators to stop blinking. The cruising range may still be displayed with a low fuel level, but it will not be accurate until enough fuel is added to stop the fuel level warning indicator from blinking.*

Unit Setting

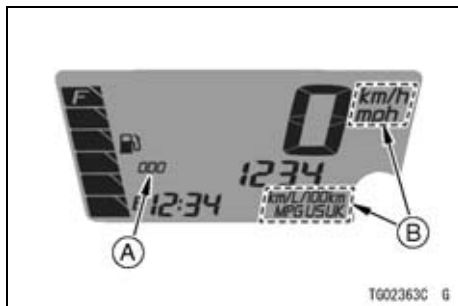

A. Odometer

B. Units

- Display the odometer in the multi-function display.
- Push the right meter button while pushing the left meter button to select the meter display units. The display units can be shifted in the following order.

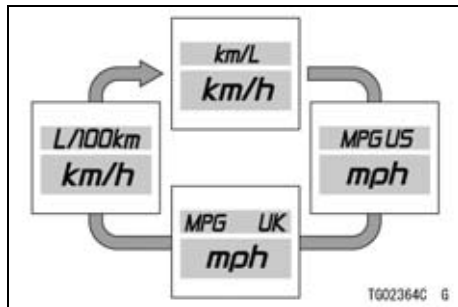

Clock

To adjust the clock:

- Push the left meter button to select the odometer.
- Push the right meter button and hold it until both the hour and minute displays blink.

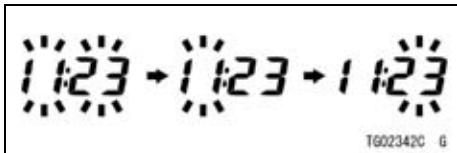

- Push the right meter button to select the hour or minute digits.
- Push the left meter button to adjust the hour or minute digits.
- To finish the adjustment, push the left meter button when both the hour and minute digits blink.

NOTE

- *When the battery is disconnected, the clock is reset to 1:00 and starts working again when the battery is connected.*

Features

Economical Riding Indicator

When riding the motorcycle efficiently, the economical riding indicator appears on the multifunction meter to indicate favorable fuel consumption. Monitoring the economical riding indicator can help the rider maximize fuel efficiency.



A. Economical Riding Indicator

⚠ WARNING

Failing to properly observe the road ahead increases the chance of an accident resulting in severe injury or death. Do not concentrate on the economical riding indicator by taking your eyes off the road; observe using peripheral vision.

Fuel Gauge

The fuel in the fuel tank is shown by the number of segments displayed.

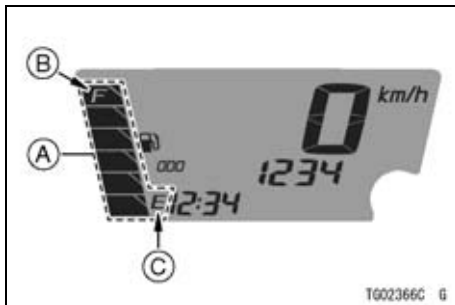

- A. Segments
- B. F (Full)
- C. E (Empty)

NOTE

- *When the fuel tank is full, all the segments are displayed. As the fuel level in the tank goes down, the segments disappear one by one from F (full) to E (empty).*
- *When the fuel level warning indicator and bottom segment blink, refer to*

56 GENERAL INFORMATION

the “When Warning Indicators Go On or Blink” of Indicators in this chapter.

Keys

You will need the key number or spare key to have a duplicate made.

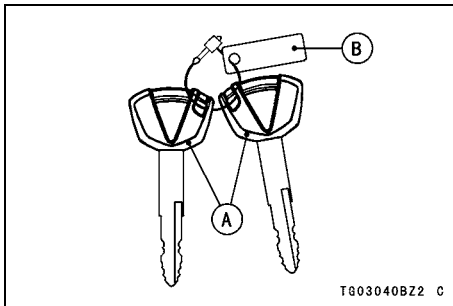

- A. Ignition Key
- B. Key Number Tag

If you lose all keys and the key number, you will need to replace the ignition

switch and all other locks operated by that key.

Contact your Kawasaki dealer to purchase additional spare keys.

Ignition Switch/Steering Lock

This is a four-position, key-operated switch.

The key can be removed when it is in the “OFF,” “LOCK” or  position.

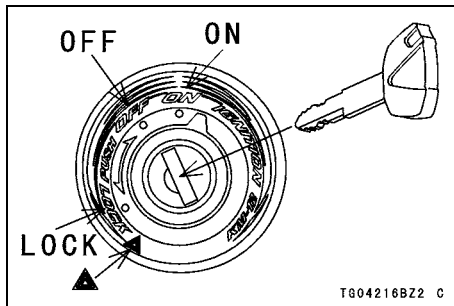

ON	<ul style="list-style-type: none"> ● Engine can be started. ● All Electrical equipment can be used. ● Key cannot be removed.
OFF	<ul style="list-style-type: none"> ● Engine off. ● Electrical equipment is off. ● Key can be removed.
LOCK	<ul style="list-style-type: none"> ● Steering locked. ● Engine off. ● Electrical equipment is off. ● Key can be removed.
	<ul style="list-style-type: none"> ● Steering locked. ● Engine off. ● Hazard lights can be used. ● Key can be removed.

For locking:

1. Turn the handlebars fully to the left.
2. Push the key down in the “OFF” position and turn it to “LOCK” or  .



TG04227B S

WARNING

Turning the ignition switch to the “OFF” position while riding the motorcycle shuts down the entire electrical system (headlight, brake light, turn signal light, etc) and the engine will stop, which could cause an accident resulting in severe injury or death. Never operate the ignition switch while riding the motorcycle; only operate it when the motorcycle is at a standstill.

NOTE

- *The tail, city and license plate lights are on whenever the ignition key is in the “ON” position. The headlight goes on when the starter button is released after starting the engine.*
- *Do not leave the ignition switch at the “ON” position for an extended time with the engine stopped, or the battery may become totally discharged.*
- *Do not leave the hazard lights switched on for a long time without the engine running or the battery will become discharged.*

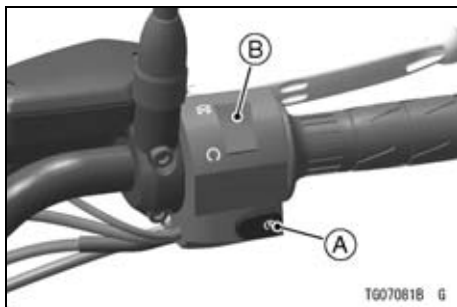
Right Handlebar Switches

- A. Starter Button**
- B. Engine Stop Switch**

Starter Button 

Refer to the Starting the Engine section for starting instructions.

Engine Stop Switch

To stop the engine in an emergency, move the engine stop switch to the  position.

Ordinarily, the engine stop switch must be in the  position for the motorcycle to operate.

NOTE

- Ordinarily, the ignition switch should be used to stop the engine.
- Although the engine stop switch stops the engine, it does not turn off all the electrical circuits and eventually the battery will be discharged.

Left Handlebar Switches

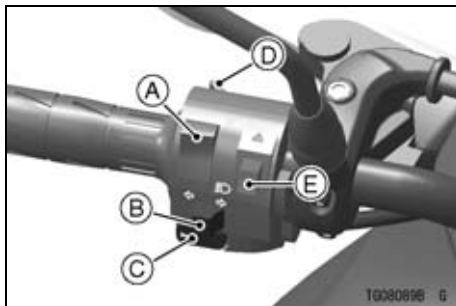

- A. Dimmer Switch
- B. Turn Signal Switch
- C. Horn Button
- D. Passing Button
- E. Hazard Switch

Dimmer Switch

High or low beam can be selected with the dimmer switch.

High beam...  (see Indicators in the Meter Instruments section)



60 GENERAL INFORMATION

Low beam...  (Single light goes on)

NOTE

- *Do not allow anything to cover the headlight lens when the headlight is on. If covered, heat can build up in the headlight lens causing lens discoloration or melting, as well as damage to the item covering the lens.*

Turn Signal Switch

When the turn signal switch is turned to the left () or right () the corresponding turn signal lights and turn signal indicator blinks. To cancel the turn signal, push the switch in.

Horn Button

When the horn button is pushed, the horn sounds.

Passing Button ^{PASS}

The high beam turns on only while the passing button is pushed.

Hazard Switch

Push in the hazard switch with the ignition switch in the “ON” position or the  position. All the turn signal lights and turn signal indicators will blink.

NOTE

- *Be careful not to use the hazard lights for an extended period of time, otherwise the battery may become totally discharged.*

Brake Lever Adjuster

While pushing the brake lever forward, rotate the adjuster and choose a suitable lever position from the five positions.

[Brake Lever Adjustment]

Adjuster Position	1	2	3	4	5
Lever Position	Far ←	—	→	Near	

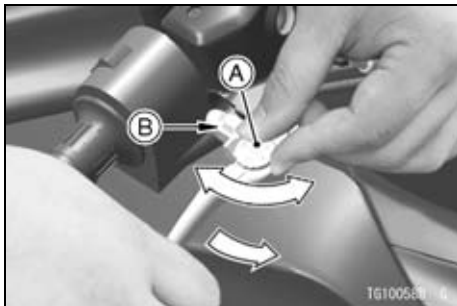

A. Adjuster
B. Mark

Clutch Lever Adjuster

While pushing the clutch lever forward, rotate the adjuster and choose a

suitable lever position from the five positions.

[Clutch Lever Adjustment]

Adjuster Position	1	2	3	4	5
Lever Position	Far ←	—	→	Near	

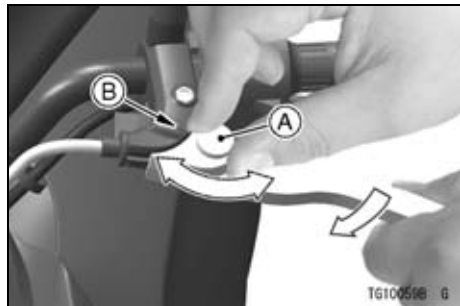

A. Adjuster
B. Mark

Fuel

WARNING

Gasoline is extremely flammable and can be explosive under certain conditions, creating the potential for serious burns. Turn the ignition switch off.

Do not smoke.

Make sure the area is well ventilated and free from any source of flame or sparks; this includes any appliance with a pilot light.

Fuel Requirements

Use clean, fresh unleaded gasoline with the following conditions.

- Antiknock Index of 87 or more
- Up to 10% of ethanol contained

NOTICE

Use only unleaded gasoline. Never use leaded gasoline. Leaded gasoline significantly reduces the capability of the catalytic converter in the exhaust system.

NOTICE

Use minimum of 87 octane gasoline only to prevent severe engine damage.

NOTICE

If engine “knocking” or “pinging” occurs, use a different brand of gasoline of a higher octane rating. If this condition is allowed to continue it can lead to severe engine damage. Gasoline quality is important. Fuels of low quality or not meeting standard industry specifications may result in unsatisfactory performance. Operating problems that result from the use of poor quality or nonrecommended fuel may not be covered under your warranty.

NOTICE

Avoid using blends of unleaded gasoline and methanol (wood alcohol) whenever possible, and never use “gasohol” containing more than 5% methanol. Fuel system damage and performance problems may result.

NOTE

- *Other oxygenates approved for use in unleaded gasoline include TAME (up to 16.7%) and ETBE (up to 17.2%). Fuel containing these oxygenates can also be used in your Kawasaki.*

NOTICE

Never use gasoline with an octane rating lower than the minimum specified by Kawasaki. Never use “gasohol” with more than 10% ethanol, or more than 5% methanol.

Gasoline containing methanol must also be blended with cosolvents and corrosion inhibitors.

Certain ingredients of gasoline may cause paint fading or damage. Be extra careful not to spill gasoline or gasoline oxygenate blends during refueling.

When not operating your Kawasaki for 30 to 60 days, mix a fuel stabilizer (such as STA-BIL) with the gasoline in the fuel tank. Fuel stabilizer additives inhibit oxidation of the fuel which minimizes gummy deposits.

Fuel Type and Octane Rating

Use clean, fresh unleaded gasoline.

The Antiknock Index is posted on service station pumps. The octane rating of a gasoline is a measure of its resistance to detonation or “knocking.” The Antiknock Index is an average of the Research Octane Number (RON) and the Motor Octane Number (MON) as shown in the table.

Fuel Type	Unleaded Gasoline
Ethanol Content	E10 or less
Antiknock Index	87 or more

NOTICE

Do not use any fuel that contains more ethanol or other oxygenates than specified for E10 fuel* in this vehicle. Damage to the engine and fuel system, or engine starting and/or performance problems may result from the use of improper fuel.

*E10 means fuel containing up to 10% ethanol.

Filling the Tank

Avoid filling the tank in the rain or where heavy dust is blowing so that the fuel does not get contaminated.

WARNING

Gasoline is extremely flammable and can be explosive under certain conditions, creating the potential for serious burns. Turn the ignition switch off. Do not smoke.

Make sure the area is well ventilated and free from any source of flame or sparks; this includes any appliance with a pilot light. Never fill the tank completely to the top.

If the tank is filled completely to the top, heat may cause the fuel to expand and overflow through the vents in the tank cap.

After refueling, make sure the tank cap is closed securely. If gasoline is spilled on the fuel tank, wipe it off immediately.

66 GENERAL INFORMATION

- Lift the key hole cover.
- Insert the ignition key into the fuel tank cap.
- Turn the key clockwise while pushing down the fuel tank cap.

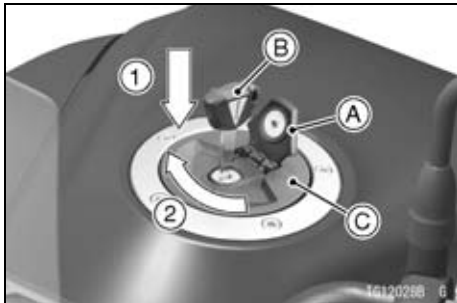

- A. Key Hole Cover
- B. Ignition Key
- C. Fuel Tank Cap

- Open the fuel tank cap.
- Add fuel.

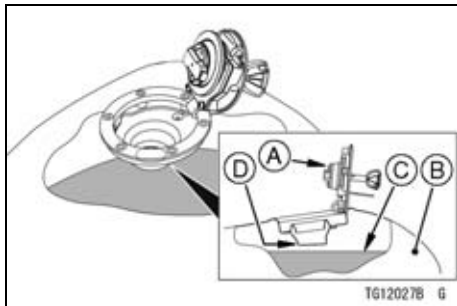

- A. Tank Cap
- B. Fuel Tank
- C. Top Level
- D. Bottom of Filler Neck (Maximum Fuel Level)

NOTE

- *Do not exceed the maximum fuel level as shown.*
- Push the fuel tank cap down into place with the key inserted.

- The key can be removed by turning counterclockwise to the original position.
- Close the key hole cover.

NOTICE

Never fill the tank completely to the top.

If the tank is filled completely to the top, heat may cause the fuel to expand and overflow through the vents in the tank cap.

After refueling, make sure the tank cap is closed securely.

If gasoline is spilled on the fuel tank, wipe it off immediately.

NOTE

- *The fuel tank cap cannot be closed without the key inserted, and the key*

cannot be removed unless the cap is locked properly.

- *Do not push on the key to close the cap, or the cap cannot be locked.*

Side Stand

Always kick the stand fully up before moving the motorcycle. The engine will stop automatically if the motorcycle is in gear and the clutch is released with the side stand down.

NOTE

- *When using the side stand, turn the handlebars to the left.*
- *Make sure the side stand is down securely before leaving the motorcycle.*
- *Do not sit on the motorcycle while it is on its side stand.*

Seat

The seat can be removed using the ignition key.

Seat Removal

- Insert the ignition key into the seat lock.
- Lift the rear part of the seat while turning the key clockwise.
- Remove the seat backward.
- Remove the ignition key.

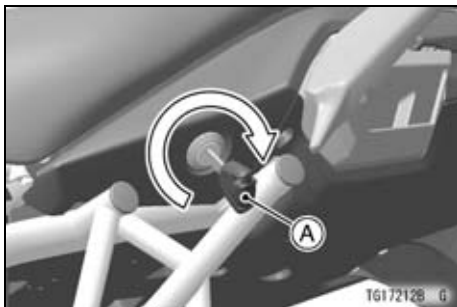

A. Ignition Key

Seat Installation

- Insert the tab at the front part of the seat under the fuel tank bracket.
- Insert the hook at the rear part of the seat into the latch hole on the frame.
- Push down the rear part of the seat until the lock clicks.

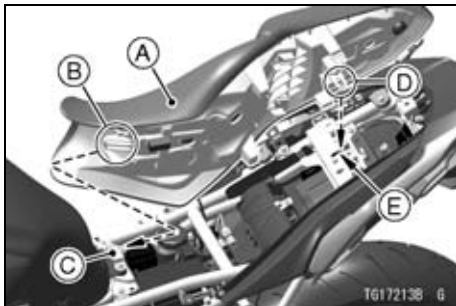

- A. Seat
- B. Tab
- C. Fuel Tank Bracket
- D. Hook
- E. Latch Hole

- Lift the front and rear ends of the seat to make sure they are securely locked.

Tool Kit

The tool kit is located under the seat. Keep the tool kit in the original place. Hold the tool kit with the band securely.

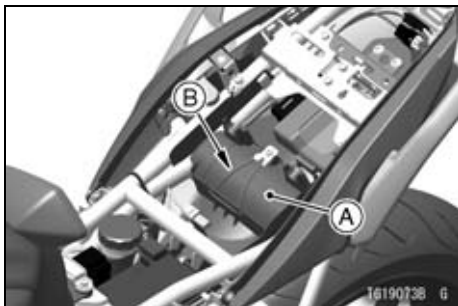

- A. Tool Kit
- B. Band

Rear View Mirrors

Rear View Mirror Adjustment

- Adjust the rear view mirror by slightly moving only the mirror portion of the assembly.
- If the rear visibility cannot be assured by moving the mirror, loosen the upper hexagonal area and turn the stay by hand.

NOTE

- *The upper hexagonal area (locknut) has left hand threads.*

70 GENERAL INFORMATION

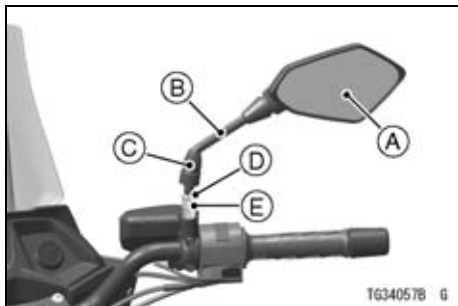

- A. Rear View Mirror
- B. Stay
- C. Rubber Boot
- D. Upper Hexagonal Area
- E. Lower Hexagonal Area

Windshield

The windshield can be adjusted up to about 60 mm (2.4 in.) in height to suit the rider's preference.

Windshield Height Adjustment

- Loosen the adjusting knobs on the windshield.

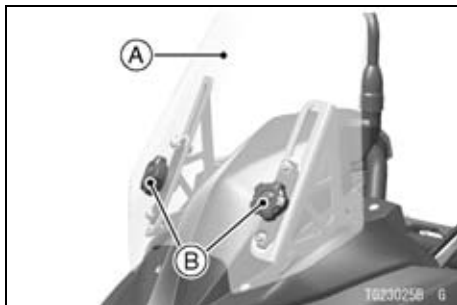

- A. Windshield
- B. Windshield Adjusting Knobs

- When moving the windshield up or down.
- Tighten the adjusting knobs on the windshield.
- Be sure the windshield is fixed securely.

Tie Hooks

When securing light loads to the seat, use the tie hooks located at the left and right grab rails.

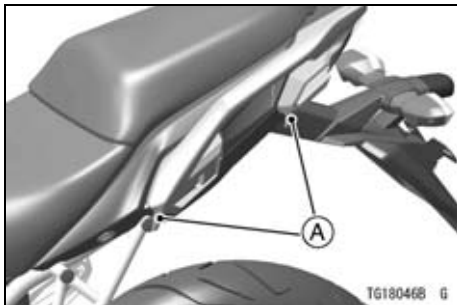

A. Tie Hooks

Helmet Hooks

Helmets can be secured to the motorcycle using the helmet hooks located under the seat.

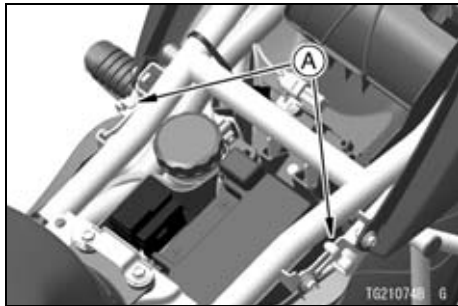

A. Helmet Hooks

 **WARNING**

Riding with helmets attached to the hooks could cause an accident by distracting the operator or interfering with normal vehicle operation. Do not ride the motorcycle with helmets attached to the hooks.

Event Data Recorder

In common with many other vehicle manufacturers, Kawasaki has equipped this motorcycle with an event data recorder (EDR). The purpose of this device is to record data, only in an accident situation, that assists with understanding of how a vehicle's systems were performing during a short period of time immediately before and during an accident (event).

NOTE

- *During normal riding data is recorded but is constantly overwritten and then erased when the ignition is switched off.*
- *At no time other than in the event of an accident is EDR data stored for retrieval.*
- *This device does not collect or store personal data or information (e.g. name, gender, age).*

This data can help provide a better understanding for both the rider and the manufacturer of how the vehicle was performing at the time of an accident and of the circumstances in which crashes occur.

The EDR in this vehicle is designed to record only data that is relevant to the vehicle's running condition at the time of an accident such information as:

- Vehicle speed,

- Engine crankshaft rotational speed, and
- Throttle opening.

To access information on an EDR, special equipment and access to the EDR is required. Kawasaki will not share EDR information without obtaining your consent, unless required by government authorities, or acting pursuant to lawful authority.

Electric Accessory Connectors

The electric power of the battery can be used through the electric accessory connectors.

- When using the electric accessory connectors, the electric accessory connection to the connectors should be done by an authorized Kawasaki dealer.

Accessory Connectors

Location	Purpose	Polarity	Wire Color
Back of Head-light	Gear Position Indicator	(+)	White/Blue
		(-)	Black/Yellow
Back of Head-light	Accessory Socket	(+)	White/Red
		(-)	Black/White
Back of Left Middle Fairing	Grip Heater	(+)	White/Blue
		(-)	Black/Yellow
Back of Left Middle Fairing	Fog Light	(+)	White/Blue
		(-)	Black/Yellow
Maximum Current: 3.3 A			

74 GENERAL INFORMATION

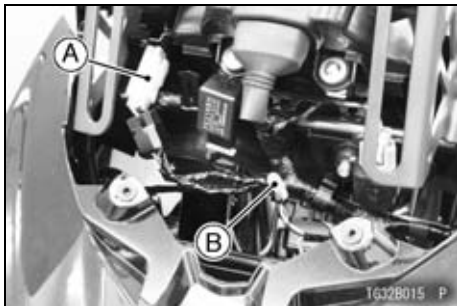

- A. For Gear Position Indicator**
- B. For Accessory Socket**

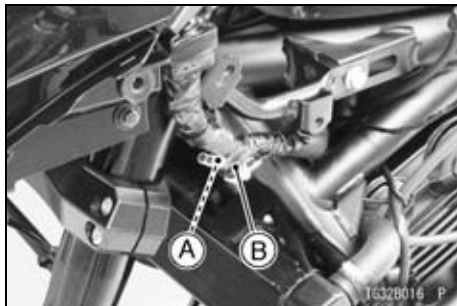

- A. For Grip Heater**
- B. For Fog Light**

NOTICE

The vehicle has electrical accessory circuit (5 A fuse) for the socket and connectors. Always install a fuse 5 A or less for the circuit. Do not connect more than 40 W of total load to the vehicle's electrical system or the battery may become discharge, even with the engine running.

HOW TO RIDE THE MOTORCYCLE

Break-In

The first 1 600 km (1 000 mile) that the motorcycle is ridden is designated as the break-in period. If the motorcycle is not used carefully during this period, you may very well end up with a “broken down” instead of a “broken in” motorcycle after a few thousand kilometers.

The following rules should be observed during the break-in period.

- The table shows maximum recommended engine speed during the break-in period.

Distance traveled	Maximum engine speed
0 ~ 800 km (0 ~ 500 mile)	4 000 r/min (rpm)
800 ~ 1 600 km (500 ~ 1 000 mile)	6 000 r/min (rpm)

NOTE

- *When operating on public roadways, keep maximum speed under traffic law limits.*
- Do not start moving or race the engine immediately after starting it, even if the engine is already warm. Run the engine for two or three minutes at idle speed to give the oil a chance to work up into all the engine parts.

- Do not race the engine while the transmission is in neutral.

⚠ WARNING

New tires are slippery and may cause loss of control and injury. A break-in period of 160 km (100 miles) is necessary to establish normal tire traction. During break-in, avoid sudden and maximum braking and acceleration, and hard cornering.

In addition to the above, at 1 000 km (600 mile) it is extremely important that the owner has the initial maintenance service performed by an authorized Kawasaki dealer.

Starting the Engine

- Check that the engine stop switch is in the  position.

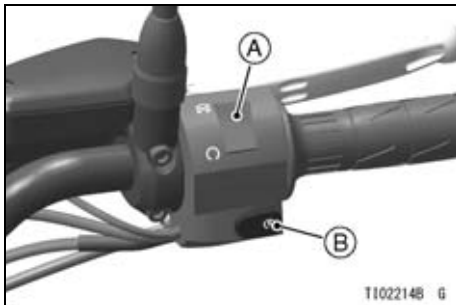

- A. Engine Stop Switch**
- B. Starter Button**

- Turn the ignition key to “ON” position.
- Make sure the transmission is in neutral.

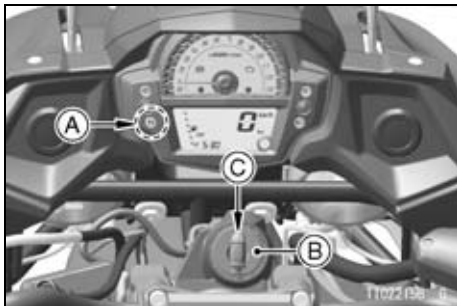

- A. Neutral Indicator (Green)
- B. Ignition Switch
- C. ON Position

NOTE

- *While the engine is cold, the fast idle system automatically raises the engine idling speed. At this time, the*

engine warning indicator () may go on if you operate the throttle grip unnecessarily.

- *The motorcycle is equipped with a vehicle-down sensor which causes the engine to stop automatically if the motorcycle falls down. The engine warning indicator () blinks when the starter button is pressed if the engine cannot be started. After righting the motorcycle, first turn the ignition key to “OFF” and then back to “ON” before starting the engine.*
- *Without holding the throttle grip, push the starter button to start the engine.*

NOTICE

Do not operate the starter continuously for more than 5 seconds, or the starter will overheat and the battery power will drop temporarily. Wait 15 seconds between each operation of the starter to let it cool and the battery power recover.

NOTE

- *The motorcycle is equipped with a starter lockout switch. This switch is designed so that the engine does not start if the transmission is in gear and the side stand is down. However, the engine can be started if the clutch lever is pulled and the side stand is fully up.*

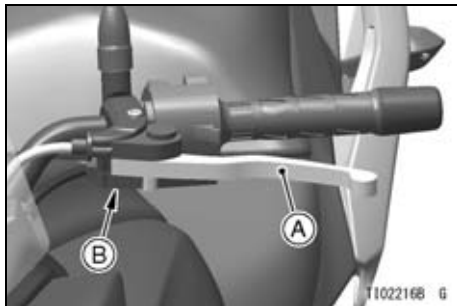

- A. Clutch Lever
- B. Starter Lockout Switch

NOTICE

Do not let the engine idle longer than 5 minutes, or engine overheating and damage may occur.

Jump Starting

If your motorcycle battery is “run down,” it should be removed and charged. If this is not practical, a 12 volt booster battery and jumper cables may be used to start the engine.

DANGER

- **Battery acid generates hydrogen gas which is flammable and explosive under certain conditions. It is present within a battery at all times, even in a discharged condition. Keep all flames and sparks (cigarettes) away from the battery.**
- **Wear eye protection when working with a battery. In the event of battery acid contact with skin, eyes, or clothing, wash the affected areas immediately with water for at least five minutes. Seek medical attention.**

Connecting Jumper Cables

- Make sure the ignition switch is turned off.

- Remove the seat (see Seat section in the GENERAL INFORMATION chapter).
- Slide the red cap from the positive (+) terminal (see Battery section in the MAINTENANCE AND ADJUSTMENT chapter).
- Connect a jumper cable from the positive (+) terminal of the booster battery to the positive (+) terminal of the motorcycle battery.

NOTICE

Be careful not to contact the jumper cable slip on the positive battery terminal to the frame, or it will cause a short circuit.

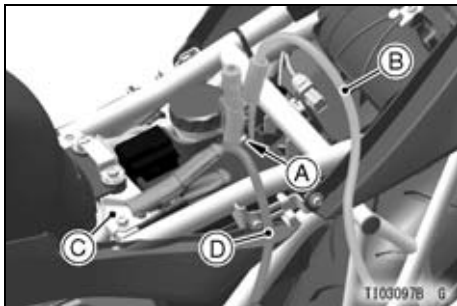

- A. Motorcycle Battery Positive (+) Terminal
- B. From Booster Battery Positive (+) Terminal
- C. Frame Bracket
- D. From Booster Battery Negative (-) Terminal

- Connect another jumper cable from the negative (-) terminal of the booster battery to your motorcycle frame bracket or other unpainted metal surface. Do not use the negative (-) terminal of the battery.

⚠ DANGER

Batteries contain sulfuric acid that can cause burns and produce hydrogen gas which is highly explosive.

- Do not make this last connection at the fuel system or battery.
- Take care not to touch the positive and negative cables together, and do not lean over the battery when making this last connection.
- Do not connect to a frozen battery. It could explode.
- Do not reverse polarity by connecting positive (+) to negative (-), or a battery explosion and serious damage to the electrical system may occur.

- Follow the standard engine starting procedure.

NOTICE

Do not operate the starter continuously for more than 5 seconds or the starter will overheat and the battery power will drop temporarily. Wait 15 seconds between each operation of the starter to let it cool and the battery power recover.

- After the engine has started, disconnect the jumper cables. Disconnect the negative (-) cable from the motorcycle first.
- Install the removed parts.

Moving Off

- Check that the side stand is up.

- Pull in the clutch lever.
- Shift into 1st gear.
- Open the throttle a little, and start to let out the clutch lever very slowly.
- As the clutch starts to engage, open the throttle a little more, giving the engine just enough fuel to keep it from stalling.

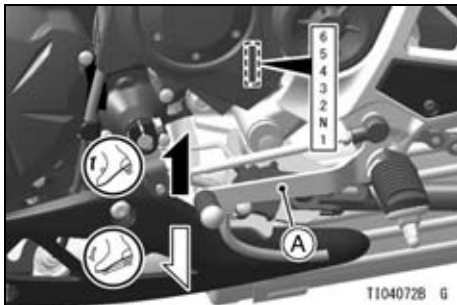

A. Shift Pedal

NOTE

- *The motorcycle is equipped with a side stand switch. This switch is designed so that the engine does not start if the transmission is in gear and the side stand is down.*

Shifting Gears

- Close the throttle while pulling in the clutch lever.
- Shift into the next higher or lower gear.
- Open the throttle part way, while releasing the clutch lever.
- For smooth riding, each gear position should cover the proper rate of speed shown in the table.

⚠ WARNING

Downshifting to a lower gear at high speed causes engine rpm to increase excessively, potentially damaging the engine and it may also cause the rear wheel to skid and cause an accident. Downshifting should be done below the vehicle speeds for each gear shown in the table.

Vehicle speed when shifting

Shifting up	km/h (mph)
1st → 2nd	15 (9)
2nd → 3rd	25 (15)
3rd → 4th	35 (21)
4th → 5th	45 (27)
5th → 6th	55 (34)

Shifting down	km/h (mph)
6th → 5th	30 (19)
5th → 4th	25 (15)
4th → 3rd	20 (12)
3rd → 2nd	15 (9)
2nd → 1st	15 (9)

NOTE

- *The transmission is equipped with a positive neutral finder. When the motorcycle is standing still, the transmission cannot be shifted past neutral from 1st gear. To use the positive neutral finder, shift down to 1st gear, then lift up on the shift pedal while standing still. The transmission will shift only into neutral.*

Braking

- Close the throttle completely, leaving the clutch engaged (except when shifting gears) so that the engine will help slow down the motorcycle.
- Shift down one gear at a time so that you are in 1st gear when you come to a complete stop.
- When stopping, always apply both brakes at the same time. Normally the front brake should be applied a little more than the rear. Shift down or fully disengage the clutch as necessary to keep the engine from stalling.
- Never lock the brakes, or it will cause the tires to skid. When turning a corner, it is better not to brake at all. Reduce your speed before you get into the corner.
- For emergency braking, disregard downshifting, and concentrate on

applying the brakes as hard as possible without skidding.

- Even in motorcycles equipped with ABS, braking during cornering may cause wheel slip. When turning a corner, it is better to limit braking to the light application of both brakes or not to brake at all. Reduce your speed before you get into the corner.

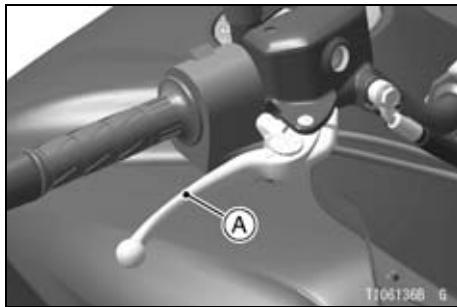

A. Front Brake Lever

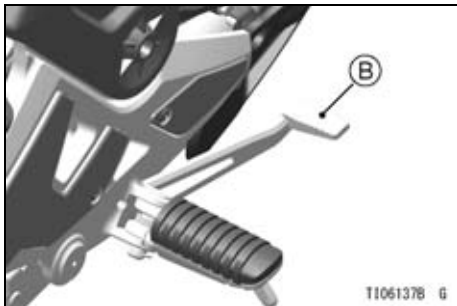

A. Rear Brake Pedal

Anti-lock Brake System (ABS)

ABS is designed to help prevent the wheels from locking up when the brakes are applied hard while running straight. The ABS automatically regulates brake force. Intermittently gaining gripping force and braking force helps

prevent wheel lock-up and allows stable steering control while stopping.

Brake control function is identical to that of a conventional motorcycle. The brake lever is used for the front brake and the brake pedal for the rear brake.

Although the ABS provides stability while stopping by preventing wheel lock-up, remember the following characteristics:

- To apply the brake effectively, use the front brake lever and rear brake pedal simultaneously in the same manner as conventional motorcycle brake system.
- ABS cannot compensate for adverse road conditions, misjudgment or improper application of brakes. You must take the same care as with motorcycles not equipped with ABS.
- ABS is not designed to shorten the braking distance. On loose, uneven or downhill surfaces, the stopping

distance of a motorcycle with ABS may be longer than that of an equivalent motorcycle without ABS. Use special caution in such areas.

- ABS will help prevent wheel lock-up when braking in a straight line, but it cannot control wheel slip which may be caused by braking during cornering. When turning a corner, it is better to limit braking to the light application of both brakes or not to brake at all. Reduce your speed before you get into the corner.
- Same as conventional brake system, an excessive sudden braking may cause wheel lock up that makes it harder to control a motorcycle.
- During braking, ABS will not prevent the rear wheel lifting.

 **WARNING**

ABS cannot protect the rider from all possible hazards and is not a substitute for safe riding practices. Be aware of how the ABS system operates and its limitations. It is the rider's responsibility to ride at appropriate speeds and manner for weather, road surface and traffic conditions.

- The computers integrated in the ABS compare vehicle speed with wheel speed. Since non-recommended tires can affect wheel speed, they may confuse the computers, which can extend braking distance.

WARNING

Use of non-recommended tires may cause malfunctioning of ABS and can lead to extended braking distance. The rider could have an accident as a result. Always use recommended standard tires for this motorcycle.

NOTE

- *When the ABS is functioning, you may feel a pulsing in the brake lever or pedal. This is normal. You need not suspend applying brakes.*
- *ABS does not function at speeds of approx. 5 km/h (3.1 mph) or below.*
- *ABS does not function if the battery is discharged. When riding with an insufficiently charged battery, ABS may not function. Keep the battery*

in good condition according to the “Battery Maintenance” section.

Stopping the Engine

- Close the throttle completely.
- Shift the transmission into neutral.
- Turn the ignition key to “OFF.”
- Support the motorcycle on a firm, level surface with the side stand.
- Lock the steering.

NOTE

- *The motorcycle is equipped with a vehicle-down sensor which causes the engine to stop automatically if the motorcycle falls down. The engine warning indicator () blinks when the starter button is pressed if the engine cannot be started. After righting the motorcycle, first turn the ignition*

key to “OFF” and then back to “ON” before starting the engine.

Stopping the Motorcycle in an Emergency

Your Kawasaki Motorcycle has been designed and manufactured to provide you optimum safety and convenience. However, in order to fully benefit from Kawasaki’s safety engineering and craftsmanship, it is essential that you, the owner and operator, properly maintain your motorcycle and become thoroughly familiar with its operation. Improper maintenance can create a dangerous situation known as throttle failure. Two of the most common causes of throttle failure are:

1. An improperly serviced or clogged air cleaner may allow dirt and dust to enter the throttle body and stick the throttle open.
2. During removal of the air cleaner, dirt is allowed to enter and jam the fuel injection system.

In an emergency situation such as throttle failure, your vehicle may be stopped by applying the brakes and disengaging the clutch. Once this stopping procedure is initiated, the engine stop switch may be used to stop the engine. If the engine stop switch is used, turn off the ignition switch after stopping the motorcycle.

Parking

WARNING

Operating or parking the vehicle near flammable materials can cause a fire, and can result in property damage or severe personal injury.

Do not idle or park your vehicle in an area where tall or dry vegetation, or other flammable materials could come into contact with the muffler or exhaust pipe.

WARNING

The engine and exhaust system get extremely hot during normal operation and can cause serious burns.

Never touch a hot engine, exhaust pipe, or muffler during operation or after stopping the engine.

- Shift the transmission into neutral and turn the ignition key to “OFF.”
- Support the motorcycle on a firm, level surface with the side stand.

NOTICE

Do not park on a soft or steeply inclined surface, or the motorcycle may fall over.

- If parking inside a garage or other structure, be sure it is well ventilated

and the motorcycle is not close to any source of flame or sparks; this includes any appliance with a pilot light.

 **WARNING**

Gasoline is extremely flammable and can be explosive under certain conditions, creating the potential for serious burns. Turn the ignition switch off. Do not smoke. Make sure the area is well ventilated and free from any source of flame or sparks; this includes any appliance with a pilot light.

- Lock the steering to help prevent theft.

NOTE

- *When stopping near traffic at night, you can leave the turn signal lights blinking for greater visibility by turning the ignition key to the  position and push in the hazard switch.*

MAINTENANCE AND ADJUSTMENT

The maintenance and adjustments outlined in this chapter must be carried out in accordance with the Daily Checks and Periodic Maintenance to keep the motorcycle in good running condition and to reduce air pollution. **The initial maintenance is vitally important and must not be neglected.**

WARNING

Failure to perform these checks or to correct a problem before operation may result in serious damage or an accident. Always perform daily checks before operation.

With a basic knowledge of mechanics and the proper use of tools, you should be able to carry out many of the maintenance items described in this chapter. If you lack proper experience or doubt your ability, all adjustments, maintenance, and repair work should be completed by a qualified technician.

Please note that Kawasaki cannot assume any responsibility for damage resulting from incorrect or improper adjustment made by the owner.

 **DANGER**

Exhaust gas contains carbon monoxide, a colorless, odorless poisonous gas. Inhaling carbon monoxide can cause serious brain injury or death. **DO NOT** run the engine in enclosed areas. Operate only in a well-ventilated area.

 **WARNING**

The cooling fan spins at high speed and can cause serious injuries. Keep your hands and clothing away from the cooling fan blades at all times.

NOTE

- *If a torque wrench is not available, the maintenance items which require a specific torque value should be serviced by an authorized Kawasaki dealer.*

Daily Checks

Check the following items each day before you ride. The time required is minimal, and habitual performance of these checks will help ensure you a safe, reliable ride.

If any irregularities are found during these checks, refer to the MAINTENANCE AND ADJUSTMENT chapter or see your dealer for the action required to return the motorcycle to a safe operating condition.

Operation	See Page
Fuel Adequate supply in tank, no leaks	–
Engine oil Oil level between level lines	102
Tires Air pressure (when cold), install the air valve cap Tire wear	136 137
Drive chain Slack Lubricate if dry	121 120

Operation	See Page
Bolts, nuts and fasteners Check for loose and/or missing bolts, nuts and fasteners	—
Steering Action smooth but not loose from lock to lock No binding of control cables	— —
Brakes Brake pad wear Brake fluid level No brake fluid leakage	126 125 —
Throttle Throttle grip free play	115
Clutch Clutch lever free play Clutch lever operates smoothly	119 —
Coolant No coolant leakage	—

96 MAINTENANCE AND ADJUSTMENT

Operation	See Page
Coolant level between level lines (when engine is cold)	106
Electrical equipment All lights (head, city, tail/brake, turn signal, license plate, warning/indicator) and horn work	—
Engine stop switch Stops engine	—
Side stand Return to its fully up position by spring tension Return spring not weak or not damaged	— —
Rear view mirrors Rear view sight	—

Periodic Maintenance

- *A: Service at number of years shown or indicated odometer reading intervals, whichever comes first.
- *B: For higher odometer readings, repeat at the frequency interval established here.
- *C: Service more frequently when operating in severe conditions: dusty, wet, muddy, high speed, or frequent starting/stopping.
- *D: California model only
- : Emission Related Item



Inspection



Dealer Inspection



Change or Replace



Dealer Change or Replace



















































Lubrication



Dealer Lubrication

98 MAINTENANCE AND ADJUSTMENT

Items	year (*A)	Odometer Reading (*B) × 1 000 km (× 1 000 mile)					See Page
		1 (0.6)	6 (3.8)	12 (7.6)	18 (11.4)	24 (15.2)	
<input type="radio"/> Air cleaner element (*C)							114
<input type="radio"/> Idle speed							118
<input type="radio"/> Throttle control system (play, smooth return, no drag)	 :1						115
<input type="radio"/> Engine vacuum synchronization							–
<input type="radio"/> Fuel system	 :1						–
<input type="radio"/> Fuel hose	 :5						–
<input type="radio"/> Evaporative emission control system (*D)							–
<input type="radio"/> Coolant level							106
<input type="radio"/> Cooling system	 :1						–

Items		year (*A)	Odometer Reading (*B) × 1 000 km (× 1 000 mile)					See Page
			1 (0.6)	6 (3.8)	12 (7.6)	18 (11.4)	24 (15.2)	
	Coolant, water hoses and O-rings	 :3	 : every 36 000 km (22 500 mile)					–
○	Valve clearance						–	
○	Air suction system						–	
	Clutch operation (play, engagement, disengagement)							119
	Engine oil and oil filter (*C)	 :1						103
	Tire air pressure	 :1						136
	Wheels and tires	 :1						137
	Wheel bearing damage	 :1						–
	Drive chain lubrication condition (*C)		 : every 600 km (400 mile)					120

100 MAINTENANCE AND ADJUSTMENT

Items	year (*A)	Odometer Reading (*B) × 1 000 km (× 1 000 mile)					See Page
		1 (0.6)	6 (3.8)	12 (7.6)	18 (11.4)	24 (15.2)	
Drive chain slack (*C)		Q: every 1 000 km (600 mile)					121
Drive chain wear (*C)				Q		Q	–
Drive chain guide wear				Q		Q	–
Brake system	Q:1	Q	Q	Q	Q	Q	–
Brake operation (effectiveness, play, no drag)	Q:1	Q	Q	Q	Q	Q	–
Brake fluid level	Q:0.5	Q	Q	Q	Q	Q	125
Brake fluid (front and rear)	G:2					G	–
Brake hoses	G:4						–
Rubber parts of brake master cylinder and caliper	G:4	G: every 48 000 km (30 000 mile)					–

Items		year (*A)	Odometer Reading (*B) × 1 000 km (× 1 000 mile)					See Page
			1 (0.6)	6 (3.8)	12 (7.6)	18 (11.4)	24 (15.2)	
	Brake pad wear (*C)			Q	Q	Q	Q	126
	Brake light switch operation		Q	Q	Q	Q	Q	127
	Suspension system	Q:1			Q		Q	–
	Steering play	Q:1	Q		Q		Q	–
	Steering stem bearings	↗:2					↗	–
	Electrical system	Q:1			Q		Q	–
○	Spark plugs				⚙		⚙	–
	Chassis parts	↗:1			↗		↗	–
	Condition of bolts, nuts and fasteners		Q		Q		Q	–

Engine Oil

Oil Level Inspection

- If the engine is cold, start the engine and run it for several minutes at idle speed.
- Stop the engine, then wait several minutes until the oil settles.

NOTICE

Racing the engine before the oil reaches every part can cause engine seizure.

- Check the engine oil level through the oil level inspection window. With the motorcycle held level, the oil level should come up between the upper and lower level lines next to the oil level inspection window.

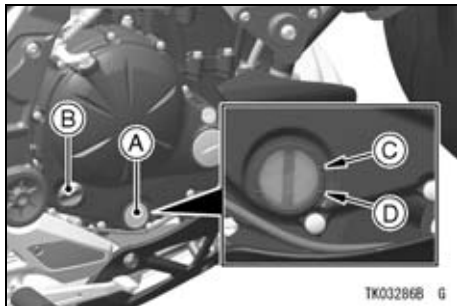

- A. Oil Level Inspection Window
- B. Oil Filler Cap
- C. Upper Level Line
- D. Lower Level Line

- If the oil level is too high, remove the excess oil through the oil filler opening using a syringe or some other suitable device.
- If the oil level is too low, add oil to reach the correct level. Use the same type and brand of oil that is already in the engine.

Oil and/or Oil Filter Change

- Remove the bolts and left lower fairing.

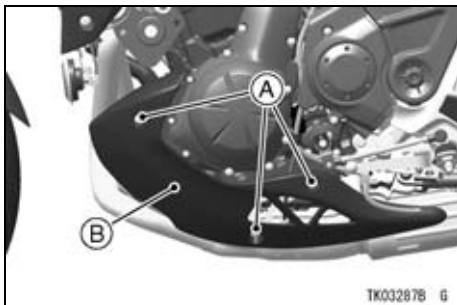

- A. Bolts
- B. Left Lower Fairing

- Warm up the engine thoroughly, and then stop it.
- Place an oil pan beneath the engine.
- Remove the engine oil drain bolt.

⚠ WARNING

Engine oil is a toxic substance. Dispose of used oil properly. Contact your local authorities for approved disposal methods or possible recycling.

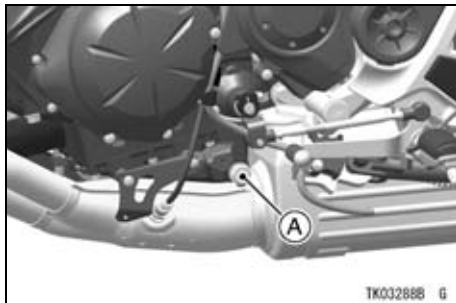

- A. Engine Oil Drain Bolt

- Let the oil completely drain with the motorcycle perpendicular to the ground.

104 MAINTENANCE AND ADJUSTMENT

- If the oil filter is to be replaced, remove the oil filter cartridge and replace it with a new one.

NOTE

- *If a torque wrench or required Kawasaki special tool is not available, this item should be serviced by an authorized Kawasaki dealer.*

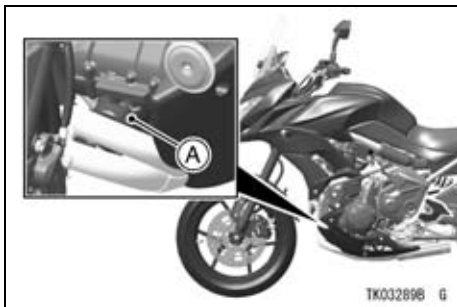

A. Oil Filter

- Apply a thin film of oil to the packing and tighten the cartridge to the specified torque.

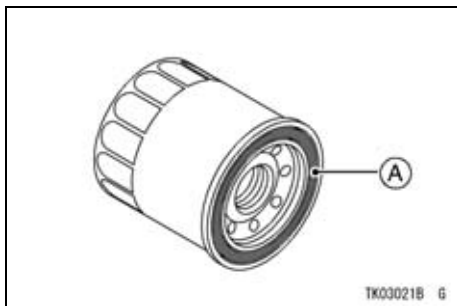

A. Packing

- Install the drain bolt with a new gasket. Tighten it to the specified torque.

NOTE

- *Replace the gasket with a new one.*

Tightening Torque

Oil Filter:

17.5 N·m (1.78 kgf·m, 12.9 ft·lb)

Engine Oil Drain Bolt:

30 N·m (3.1 kgf·m, 22 ft·lb)

- Fill the engine up to the upper level line with a good quality engine oil specified in the table.

Recommended Engine Oil

Type:

Kawasaki Performance 4-Stroke
Motorcycle Oil*

Kawasaki Performance 4-Stroke
Semi-Synthetic Oil*

Kawasaki Performance 4-Stroke Full
Synthetic Oil*

or other 4-stroke oils with API SG, SH,
SJ, SL or SM with JASO MA, MA1 or
MA2 rating

Viscosity:

SAE 10W-40

*Kawasaki Performance Oils and Lubricants have been specifically engineered for your vehicle. Consistent use of these products meets or exceeds warranty and service requirements and can help to extend the life of your Kawasaki.

NOTE

- *Do not add any chemical additive to the oil. Oils fulfilling the above requirements are fully formulated and provide adequate lubrication for both the engine and the clutch.*

Engine Oil Capacity

1.6 L (1.7 US qt)

[when filter is not removed]

1.8 L (1.9 US qt)

[when filter is removed]

106 MAINTENANCE AND ADJUSTMENT

Although 10W-40 engine oil is the recommended oil for most conditions, the oil viscosity may need to be changed to accommodate atmospheric conditions in your riding area.

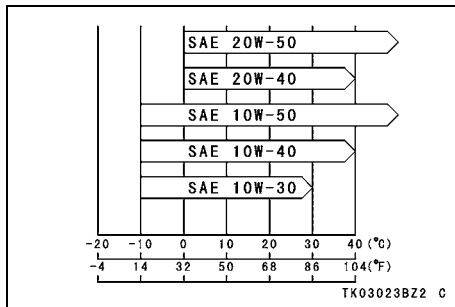

- Install the left lower fairing and tighten the bolts.

- Start the engine.
- Check the oil level and oil leakage.

Coolant

Coolant Level Inspection

- Position the motorcycle so that it is perpendicular to the ground.
- Check the coolant level through the coolant level gauge on the reserve tank located in back of the middle fairing. The coolant level should be between the F (Full) and L (Low) level lines.

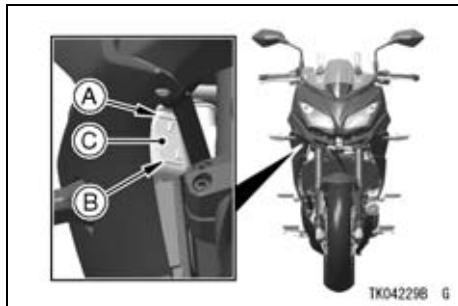

- A. F (Full) Level Line
- B. L (Low) Level Line
- C. Reserve Tank

NOTE

- Check the level when the engine is cold (room or atmospheric temperature).
- If the amount of coolant is insufficient, add coolant into the reserve tank.

Coolant Filling Quick Rivet Removal

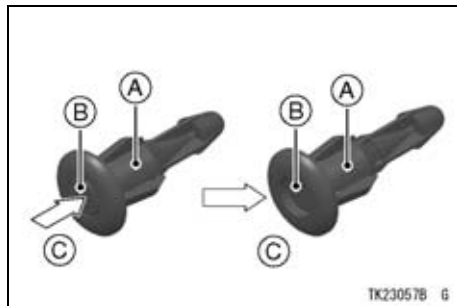

- A. Quick Rivet
- B. Center Pin
- C. Push in.

Quick Rivet Installation

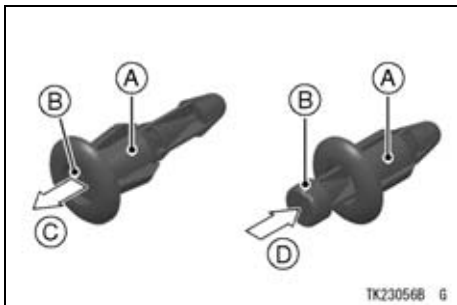

- A. Quick Rivet
- B. Center Pin
- C. Pull up fully.
- D. Push in.

- Remove the quick rivet.
- Remove the bolts and washers.
- Remove the bolt and collar.



- A. Quick Rivet
- B. Bolts and Washers
- C. Bolt and Collar

- Pull the rear part of right middle fairing outward to clear the projections.

NOTE

- *To protect the hook and tab, hold the middle part of middle fairing.*



A. Projections

- Clear the hook and tab of the middle fairing from the inner cover.

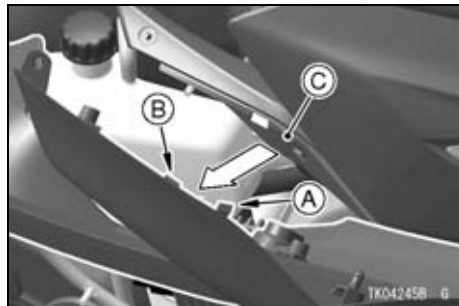

- A. Hook**
- B. Tab**
- C. Inner Cover**

- Pull the front part of middle fairing outward to clear the projections.

110 MAINTENANCE AND ADJUSTMENT



A. Projections

- Disconnect the right turn signal light lead connector, and remove the right middle fairing.



A. Right Turn Signal Light Lead Connector

- Remove the cap from the reserve tank and add coolant through the filler opening to the F (Full) level line.

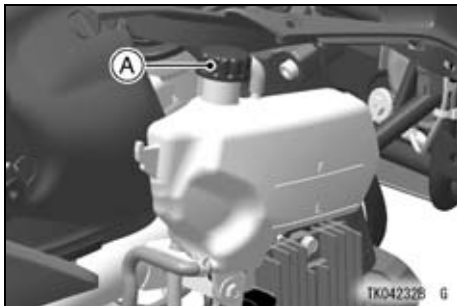

A. Reserve Tank Cap

NOTE

○ *In an emergency you can add water alone to the coolant reserve tank, however it must be returned to the correct mixture ratio by the addition of antifreeze concentrate as soon as possible.*

NOTICE

If coolant must be added often, or the reserve tank completely runs dry, there is probably leakage in the system. Have the cooling system inspected by your authorized Kawasaki dealer.

- Install the reserve tank cap.
- Connect the right turn signal light lead connector.
- Insert the projections at the front part of middle fairing into the grommets on the upper fairing.

112 MAINTENANCE AND ADJUSTMENT

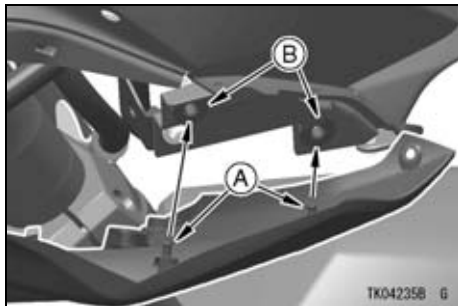

- A. Projections
- B. Grommets

- Insert the hook and tab on the middle fairing into the slots on the inner cover.

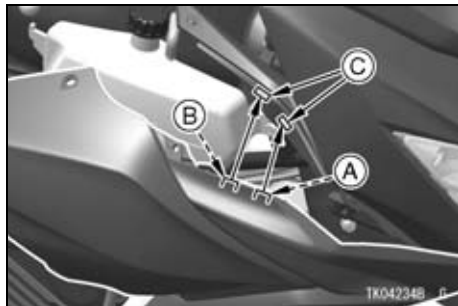

- A. Hook
- B. Tab
- C. Slots

- Insert the projections at the rear part of middle fairing into the grommets on the fuel tank and frame.



A. Projections

B. Grommets

- Install the washers and collar.
- Tighten the bolts.
- Install the quick rivet.

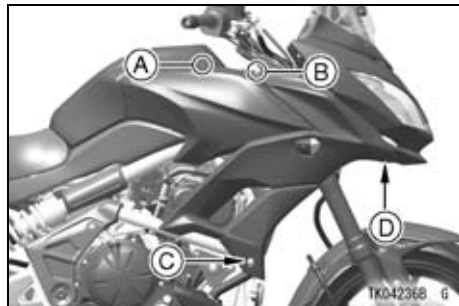

A. Washer and M5 Bolt, L = 12 mm (0.47 in.)

B. Washer and M5 Bolt, L = 16 mm (0.63 in.)

C. Collar and M6 Bolt, L = 14 mm (0.55 in.)

D. Quick Rivet

Coolant Change

Have the coolant changed by an authorized Kawasaki dealer.

*Coolant Requirement***⚠ WARNING**

Coolant containing corrosion inhibitors for aluminum engines and radiators include harmful chemicals for human body. Drinking coolant can result in serious injury or death. Use coolant in accordance with the instructions of the manufacturer.

Use a permanent type of antifreeze (soft water and ethylene glycol plus corrosion and rust inhibitor chemicals for aluminum engines and radiators) in the cooling system. On the mixture ratio of coolant, choose the suitable one referring to the relation between freezing point and strength directed on the container.

NOTICE

If hard water is used in the system, it causes scale accumulation in the water passages, and considerably reduces the efficiency of the cooling system.

NOTE

- *A permanent type of antifreeze is installed in the cooling system when shipped. It is mixed at 50% and has the freezing point of -35°C (-31°F).*

Air Cleaner

This motorcycle's air cleaner element consists of a wet paper filter. Cleaning and replacement of the air cleaner element should be done by an authorized Kawasaki dealer.

Oil Draining

- Inspect the transparent drain hose located to the left of the engine to see if any oil has run down.

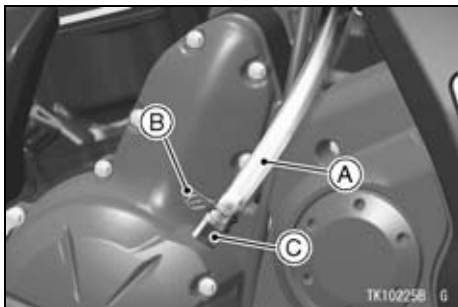

- A. Transparent Drain Hose
- B. Clamp
- C. Plug

- If there is any oil in the transparent drain hose, remove the clamp and plug from the lower end of the drain hose, and drain the oil.

⚠ WARNING

Oil on tires will make them slippery and can cause an accident and injury. Be sure to install the plug in the drain hose after draining.

Throttle Control System

Throttle Grip

Throttle Grip Free Play Inspection

- Check that the throttle grip moves smoothly from full open to close, and the throttle closes quickly and completely by the return spring in all steering positions.
- If the throttle grip does not return properly, have the throttle control system checked by an authorized Kawasaki dealer.

116 MAINTENANCE AND ADJUSTMENT

- Check the throttle grip free play by turning back and forth.

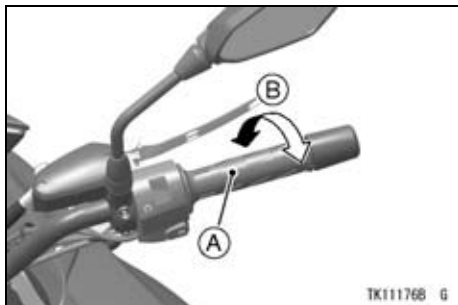

- A. Throttle Grip
- B. Throttle Grip Free Play

Throttle Grip Free Play

2 ~ 3 mm (0.08 ~ 0.12 in.)

- If there is improper play, adjust it.

Throttle Grip Free Play Adjustment

- Loosen the locknut at the upper end of the accelerator cable, and turn the adjuster until the proper amount of throttle grip free play is obtained.

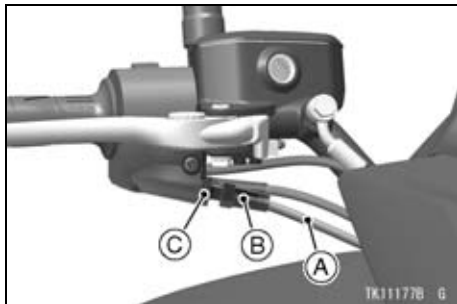

- A. Accelerator Cable
- B. Adjuster
- C. Locknut

- If the throttle grip free play cannot be adjusted with the accelerator cable adjuster at the throttle grip, use the

decelerator cable adjuster located under the fuel tank.

- Remove the right middle fairing (see Coolant section).
- Turn out the decelerator cable adjuster until there is no play when the throttle grip is completely closed. Tighten the locknut.

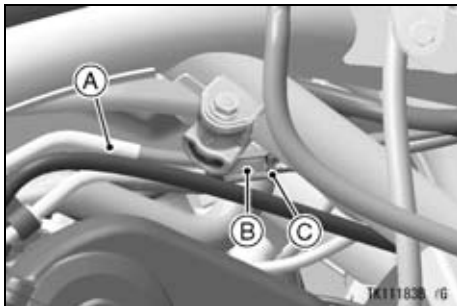

- A. Decelerator Cable
 B. Adjuster
 C. Locknut

- Turn out the accelerator cable adjuster until 2 ~ 3 mm (0.08 ~ 0.12 in.) of throttle grip play is obtained. Tighten the locknut.
- With the engine idling, turn the handlebars to each side. If handlebars movement changes the idle speed, the throttle cables may be improperly adjusted or incorrectly routed, or they may be damaged. Be sure to correct any of these conditions before riding.

⚠ WARNING

Operation with improperly adjusted, incorrectly routed, or damaged cables could result in an unsafe riding condition. Be sure the control cables are adjusted and routed correctly, and are free from damage.

Idle Speed

Idle Speed Adjustment

- Start the engine, and warm it up thoroughly.
- Adjust the idle speed by turning the idle adjusting screw.

NOTE

- *While the engine is cold, the fast idle system automatically raises the engine idling speed.*

Idle Speed

1 250 ~ 1 350 r/min (rpm)



A. Idle Adjusting Screw

- Open and close the throttle a few times to make sure that the idle speed does not change. Readjust if necessary.
- With the engine idling, turn the handlebars to each side. If handlebars movement changes the idle speed, the throttle cables may be improperly adjusted or incorrectly routed, or they may be damaged. Be sure to correct any of these conditions before riding.

⚠ WARNING

Operation with damaged cables could result in an unsafe riding condition. Replace damaged control cables before operation.

Clutch

Clutch Operation Inspection

- Check that the clutch lever operates properly and that the inner cable slides smoothly. If there is any irregularity, have the clutch cable checked by an authorized Kawasaki dealer.
- Check the clutch lever free play.

Clutch Lever Free Play

2 ~ 3 mm (0.08 ~ 0.12 in.)

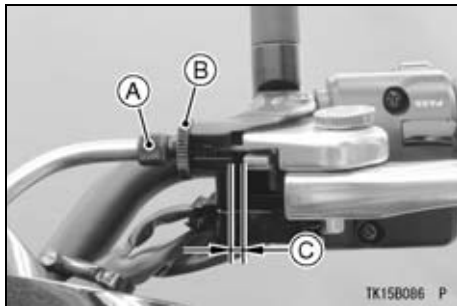

- A. Adjuster
- B. Locknut
- C. Clutch Lever Free Play

- If the free play is incorrect, adjust the clutch lever free play as follows.

Clutch Lever Free Play Adjustment

- Loosen the locknut, and turn the adjuster so that the clutch lever will have the specified free play.

⚠ WARNING

Excess clutch lever free play could prevent clutch disengagement and cause a crash resulting in serious injury or death. When adjusting the clutch lever free play, be sure the upper end of the clutch outer cable is fully seated in its fitting so that it doesn't slip into place later and create excessive free play.

- If it cannot be done, have the clutch cable adjusted by an authorized Kawasaki dealer.

Drive Chain

Drive Chain Lubrication

Lubrication is necessary after riding through rain or on wet roads, or any time that the chain appears dry.

Use a lubricant for sealed chains to prevent deterioration of chain seals. If the chain is especially dirty, clean it using a cleaner for sealed chains following the instructions supplied by the chain cleaner manufacturer.

- Apply lubricant to the sides of the rollers so that it will penetrate to the rollers and bushings. Apply lubricant to the seals so that the seals will be coated with lubricant. Wipe off any excess lubricant.

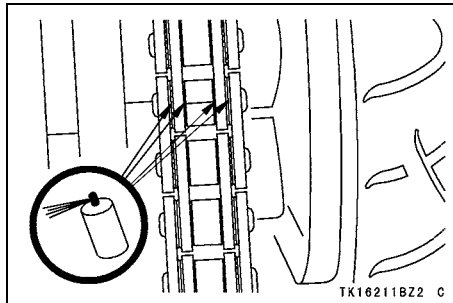

- Wipe off any lubricant that gets on the tire surface.

Drive Chain Slack Inspection

- Set the motorcycle up on its side stand.
- Clean the chain if it is dirty, and lubricate it if it appears dry.
- Rotate the rear wheel to find the position where the chain is tightest, and measure the maximum chain slack by pulling up and pushing down the chain midway between the engine sprocket and rear wheel sprocket.

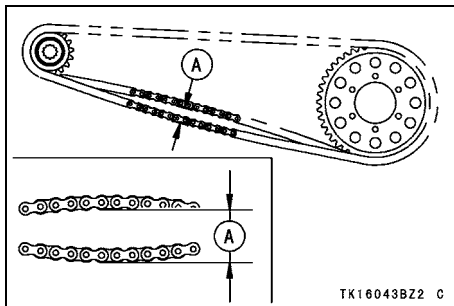

A. Chain Slack

- If the drive chain is too tight or too loose, adjust it so that the chain slack is within the standard value.

Drive Chain Slack

Standard: 25 ~ 35 mm (1.0 ~ 1.4 in.)

Drive Chain Slack Adjustment

- Loosen the left and right chain adjuster locknuts.

122 MAINTENANCE AND ADJUSTMENT

- Remove the cotter pin, and loosen the axle nut.

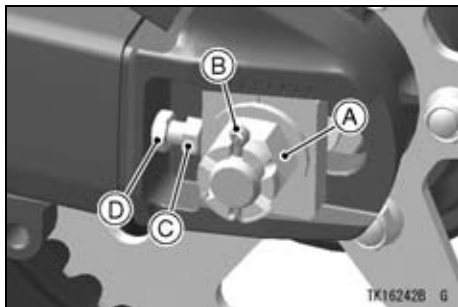

- A. Axle Nut
- B. Cotter Pin
- C. Adjuster
- D. Locknut

- If the chain is too loose, turn out the left and right chain adjusters evenly.
- If the chain is too tight, turn in the left and right chain adjusters evenly.
- Turn both chain adjusters evenly until the drive chain has the correct amount of slack. To keep the chain and wheel properly aligned, the notch on the left wheel alignment indicator should align with the same swingarm mark that the right indicator notch aligns with.

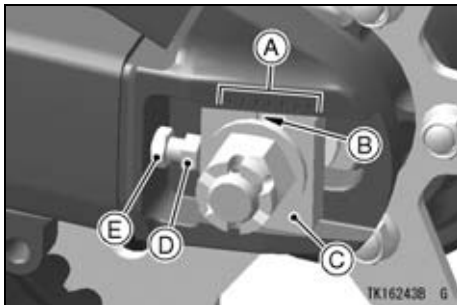

- A. Marks
- B. Notch
- C. Indicator
- D. Adjuster
- E. Locknut

NOTE

- *Wheel alignment can also be checked using the straightedge or string method.*

⚠ WARNING

Misalignment of the wheel will result in abnormal wear, and may result in an unsafe riding condition. Align the rear wheel using the marks on the swingarm or measuring the distance between the center of the axle and swingarm pivot.

- Tighten both chain adjuster locknuts.
- Tighten the axle nut to the specified torque.

Tightening Torque

Axle Nut: 108 N·m (11.0 kgf·m, 79.7 ft·lb)

NOTE

- *If a torque wrench is not available, this item should be serviced by an authorized Kawasaki dealer.*

124 MAINTENANCE AND ADJUSTMENT

- Rotate the wheel, measure the chain slack again at the tightest position, and readjust if necessary.
- Install a new cotter pin through the axle nut and axle, and spread its ends.

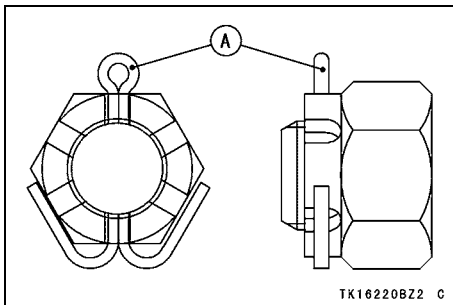

A. Cotter Pin

the cotter pin hole in the axle shaft, tighten the nut clockwise up to the next alignment.

- *It should be within 30 degrees.*
- *Loosen once and tighten again when the slot goes past the nearest hole.*

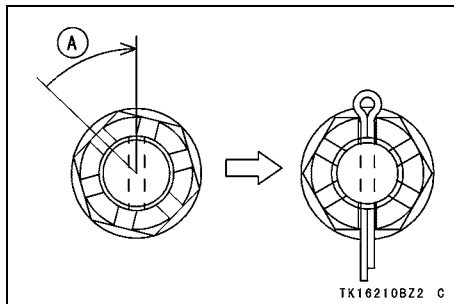

A. Turn Clockwise

NOTE

- *When inserting the cotter pin, if the slots in the nut do not align with*

 **WARNING**

A loose axle nut can lead to an accident resulting in serious injury or death. Tighten the axle nut to the proper torque and install a new cotter pin.

- Check the rear brake (see Brakes section).

Brakes

If you feel there is something wrong when applying the brakes, have the brake system checked by an authorized Kawasaki dealer immediately.

 **WARNING**

Air in the brake lines diminish braking performance and can cause an accident resulting in injury or death. If the brake lever or pedal feels mushy when it is applied, there might be air in the brake lines or the brake may be defective. Have the brake checked immediately by an authorized Kawasaki dealer.

Brake Fluid Level Inspection

- With the front brake fluid reservoir held horizontal, the brake fluid level must be above the lower level line.

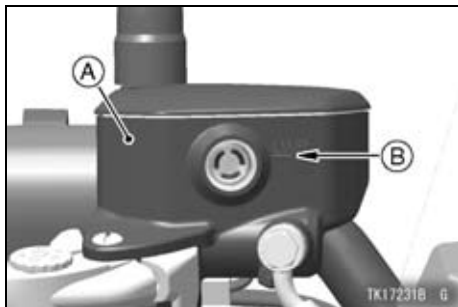

A. Front Brake Fluid Reservoir
B. Lower Level Line

- With the rear brake fluid reservoir held horizontal, the brake fluid level must be kept between the upper and lower level lines.

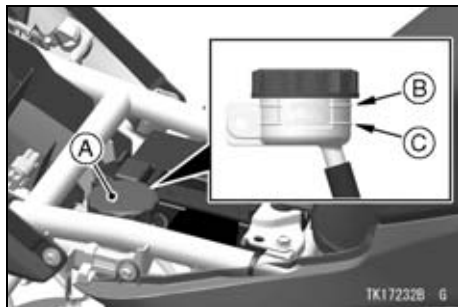

A. Rear Brake Fluid Reservoir
B. Upper Level Line
C. Lower Level Line

- If the fluid level is lower than the lower level line it may indicate that the fluid is leaking. In this case, have the brake system inspected by an authorized Kawasaki dealer.

Brake Pad Wear Inspection

Inspect the brakes for wear. For each front and rear disc brake caliper, if the

thickness of either pad lining is less than 1 mm (0.04 in.), replace both pads in the caliper as a set. Pad replacement should be done by an authorized Kawasaki dealer.

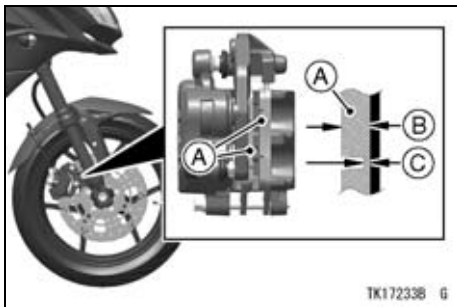

- A. Front Brake Pads
- B. Lining Thickness
- C. 1 mm (0.04 in.)

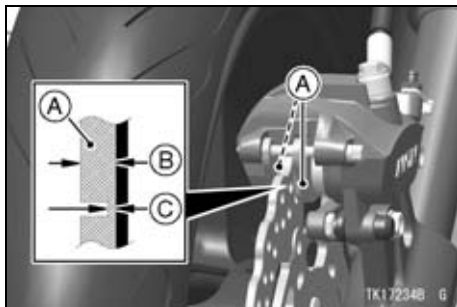

- A. Rear Brake Pads
- B. Lining Thickness
- C. 1 mm (0.04 in.)

Brake Light Switches

Brake Light Switch Inspection

- Turn the ignition switch on.
- The brake light should go on when the front brake is applied.

128 MAINTENANCE AND ADJUSTMENT

- If it does not, ask your authorized Kawasaki dealer to inspect the front brake light switch.
- Check the operation of the rear brake light switch by depressing the brake pedal. The brake light should go on after the proper pedal travel.

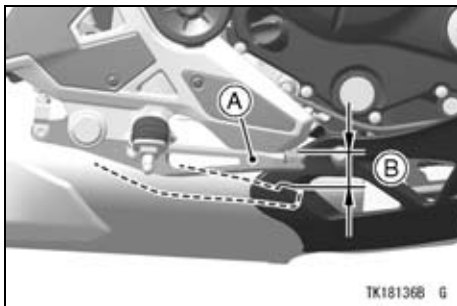

- A. Brake Pedal**
B. 12 mm (0.47 in.)

- If the light does not come on, adjust the rear brake light switch.

Brake Pedal Travel

12 mm (0.47 in.)

Brake Light Switch Adjustment

- To adjust the rear brake light switch, move the switch up or down by turning the adjusting nut.

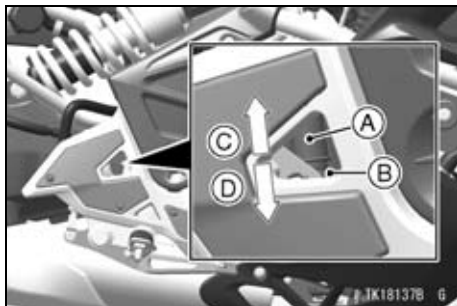

- A. Rear Brake Light Switch**
B. Adjusting Nut
C. Lights sooner
D. Lights later

NOTICE

To avoid damaging the electrical connections inside the switch, be sure that the switch body does not turn during adjustment.

Suspension System**Front Fork****Spring Preload Adjustment**

The adjuster is located at the top of left front fork leg.

Standard

6 1/2 turns in

In from the fully seated position (turned fully counterclockwise).

- Turn the adjuster clockwise to increase spring preload and stiffen the suspension.
- Turn the adjuster counterclockwise to decrease spring preload and soften the suspension.

NOTICE

Do not turn the adjuster beyond the fully seated position or the adjusting mechanism may be damaged.

NOTE

- *The spring preload adjuster can be turned with the allen wrench or suitable tool.*

130 MAINTENANCE AND ADJUSTMENT

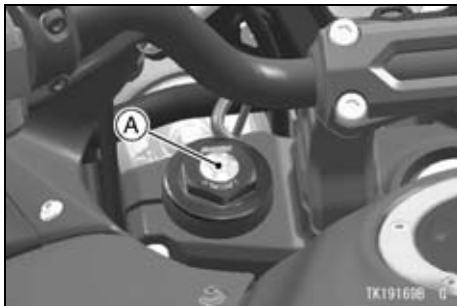

A. Spring Preload Adjuster

Rebound Damping Force Adjustment

The adjuster is located at the top of right front fork leg.

Standard

2 1/2 turns out

Out from the fully seated position (turned fully clockwise).

- Turn the adjuster clockwise with a flat tip screwdriver to increase damping force.
- Turn the adjuster counterclockwise to decrease damping force.

NOTICE

Do not turn the adjuster beyond the fully seated position or the adjusting mechanism may be damaged.

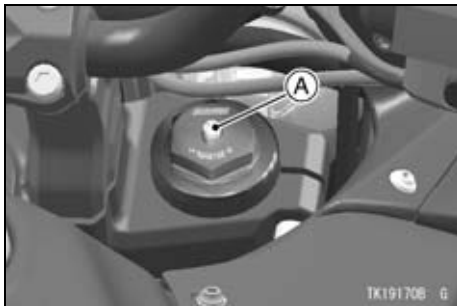

A. Rebound Damping Force Adjuster

Rear Shock Absorber

Spring Preload Adjustment

The adjuster is located above the rear shock absorber.

Standard

1 click

In from the fully seated position (turned fully counterclockwise).

- Turn the adjuster clockwise to increase spring preload.
- Turn the adjuster counterclockwise to decrease spring preload.

NOTICE

Do not turn the adjuster beyond the fully seated position or the adjusting mechanism may be damaged.

132 MAINTENANCE AND ADJUSTMENT

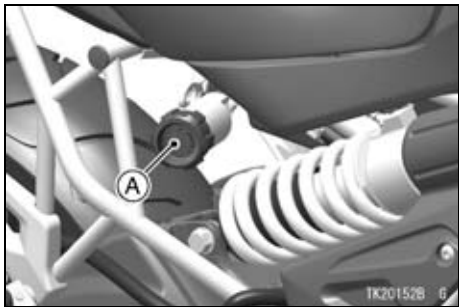

A. Spring Preload Adjuster

Setting Tables

Front Fork Spring Preload Setting

	Softest setting limit	Standard	Hardest setting limit
Adjuster Position	0*	6 1/2 turns in**	20 turns in**
Spring Action	Weak	←→	Strong
Setting	Soft	←→	Hard
Load	Light	←→	Heavy
Road	Good	←→	Bad
Speed	Low	←→	High

*: This position is the fully seated position (turned fully counterclockwise).

** : In from the fully seated position (turned fully counterclockwise). This adjustment range may not exactly match the number shown in the table due to small tolerance of production.

134 MAINTENANCE AND ADJUSTMENT

Front Fork Damping Force Settings

		Softest setting limit	Standard	Hardest setting limit
Adjuster Position:	Rebound	3 turns out**	2 1/2 turns out**	0*
Damping Force		Weak	←→	Strong
Setting		Soft	←→	Hard
Load		Light	←→	Heavy
Road		Good	←→	Bad
Speed		Low	←→	High

*: This position is the fully seated position (turned fully clockwise).

** : Out from the fully seated position (turned fully clockwise). This adjustment range may not exactly match the number shown in the table due to small tolerance of production.

Rear Shock Absorber Spring Preload Setting

	Softest setting limit	Standard	Hardest setting limit
Adjuster Position	0*	1 click**	24 clicks**
Spring Action	Weak	←→	Strong
Setting	Soft	←→	Hard
Load	Light	←→	Heavy
Road	Good	←→	Bad
Speed	Low	←→	High

*: This position is the fully seated position (turned fully counterclockwise).

** : In from the fully seated position (turned fully counterclockwise). This adjustment range may not exactly match the number shown in the table due to small tolerance of production.

The recommended setting positions of the spring preload adjuster are as follows:

No passenger with top case and pannier cases	16 clicks**
A passenger with top case and pannier cases	24 clicks**

Wheels

Tire Pressure Inspection

- Remove the air valve cap.
- Check the tire pressure often, using an accurate gauge.
- Make sure to install the air valve cap securely.

NOTE

- *Measure the tire pressure when the tires are cold (that is, when the motorcycle has not been ridden more than a mile during the past 3 hours).*
- *Tire pressure is affected by changes in ambient temperature and altitude, and so the tire pressure should be checked and adjusted when your riding involves wide variations in temperature or altitude.*

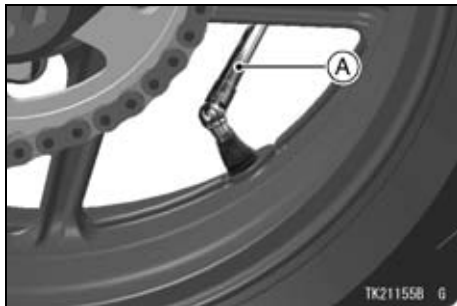

A. Tire Pressure Gauge

Tire Air Pressure (when cold)

~ 150 kg (331 lb)	
Front	225 kPa (2.25 kgf/cm ² , 33 psi)
Rear	250 kPa (2.50 kgf/cm ² , 36 psi)
150 ~ 210 kg (331 ~ 463 lb)	
Front	225 kPa (2.25 kgf/cm ² , 33 psi)
Rear	290 kPa (2.90 kgf/cm ² , 42 psi)

Tire Wear, Damage

As the tire tread wears down, the tire becomes more susceptible to puncture and failure. An accepted estimate is that 90% of all tire failures occur during the last 10% of tread life (90% worn). So it is false economy and unsafe to use the tires until they are bald.

Tire Wear Inspection

- Measure the depth of the tread with a depth gauge, and replace any tire that has worn down to the minimum allowable tread depth.



A. Tire Depth Gauge

Minimum Tread Depth

Front	—	1 mm (0.04 in.)
Rear	Under 130 km/h (80 mph)	2 mm (0.08 in.)
	Over 130 km/h (80 mph)	3 mm (0.12 in.)

- Visually inspect the tire for cracks and cuts, replacing the tire in case of bad damage. Swelling or high spots

138 MAINTENANCE AND ADJUSTMENT

indicate internal damage, requiring tire replacement.

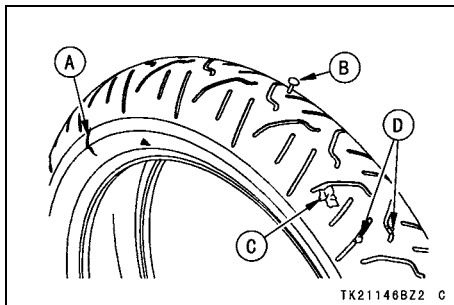

TK21148BZ2 C

- A. Crack or Cut
- B. Nail
- C. Swelling or High Spot
- D. Stone

- Remove any imbedded stones or other foreign particles from the tread.

NOTE

- *Have the wheel balance inspected whenever a new tire is installed.*

WARNING

Tires that have been punctured and repaired do not have the same capabilities as undamaged tires and can suddenly fail, causing an accident resulting in serious injury or death. Replace damaged tires as soon as possible. To ensure safe handling and stability, use only the recommended standard tires for replacement, inflated to the standard pressure. If it is necessary to ride on a repaired tire, do not exceed 100 km/h (60 mph) until the tire is replaced.

NOTE

- *When operating on public roadways, keep maximum speed under traffic law limits.*

Standard Tire (Tubeless)

Front	Make, Type: DUNLOP, D222F J Size: 120/70ZR17 M/C (58W)
Rear	Make, Type: DUNLOP, D222 J Size: 160/60ZR17 M/C (69W)

 WARNING

Mixing tire brands and types can adversely affect handling and cause an accident resulting in injury or death. Always use the same manufacturer's tires on both front and rear wheels.

 WARNING

New tires are slippery and may cause loss of control and injury. A break-in period of 160 km (100 miles) is necessary to establish normal tire traction. During break-in, avoid sudden and maximum braking and acceleration, and hard cornering.

Battery

The battery installed in this motorcycle is a sealed type, so it is not necessary to check the battery electrolyte level or add distilled water.

NOTICE

Never remove the sealing strip, or the battery can be damaged. Do not install a conventional battery in this motorcycle, or the electrical system cannot work properly.

Make	Siam Furukawa
Type	FTX12-BS

Battery Maintenance

It is the owner's responsibility to keep the battery fully charged. Failure to do so can lead to battery failure and leave you stranded.

If you are riding your vehicle infrequently, inspect the battery voltage weekly using a voltmeter. If it drops below 12.6 volts, the battery should be charged using an appropriate charger (check with your Kawasaki dealer).

If you will not be using the motorcycle for longer than two weeks, the battery should be charged using an appropriate charger. Do not use an automotive-type quick charger that may overcharge the battery and damage it.

NOTE

- *Leaving the battery connected causes the electrical components (clock etc) to make the battery discharged, resulting the over discharge of the battery. In this case, the repair or replacement of the battery is not included in the warranty. If you do not drive for four weeks or more, disconnect the battery from the vehicle.*

Kawasaki-recommended chargers are:

Battery Mate 150-9
 OptiMate 4
 Yuasa MB-2040/2060
 Christie C10122S

If the above chargers are not available, use equivalent one.

For more details, ask your Kawasaki dealer.

Battery Charging

- Charge the battery following the instructions of your battery charger.
- The charger will keep the battery fully charged until you are ready to re-install the battery in the motorcycle (see Battery Installation).

DANGER

- **Battery acid generates hydrogen gas which is flammable and explosive under certain conditions. It is present within a battery at all times, even in a discharged condition. Keep all flames and sparks (cigarettes) away from the battery.**
- **Wear eye protection when working with a battery. In the event of battery acid contact with skin, eyes, or clothing, wash the affected areas immediately with water for at least five minutes. Seek medical attention.**

⚠ WARNING

Battery posts, terminals and related accessories contain lead and lead compounds, chemicals known to the State of California to cause cancer and reproductive harm. Wash hands after handling.

Battery Removal

- Make sure the ignition switch is turned off.
- Remove the seat. Refer to the Seat section in the GENERAL INFORMATION chapter.
- Disconnect the negative (-) cable from the (-) terminal.
- Slide the red cap from the positive (+) terminal.
- Disconnect the positive (+) cable from the (+) terminal.

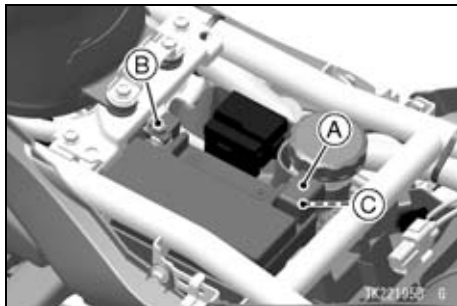

- A. Red Cap**
- B. (-) Terminal**
- C. (+) Terminal**

- Take the battery out of the battery case.
- Clean the battery using a solution of baking soda and water. Be sure that the cable connections are clean.

Battery Installation

- Place the battery on the battery case.

- Connect the (+) cable to the (+) terminal, and then connect the (-) cable to the (-) terminal.

NOTICE

Installing the (-) cable to the (+) terminal of the battery or the (+) cable to the (-) terminal of the battery can seriously damage the electrical system.

- Put a light coat of grease on the terminals to prevent corrosion.
- Cover the (+) terminal with the red cap.
- Install the removed parts.

Headlight

Headlight aiming should be done by an authorized Kawasaki dealer.

Horizontal Adjustment

The headlight beam is adjustable horizontally. If not properly adjusted horizontally, the beam will point to one side rather than straight ahead.

- Turn the horizontal adjuster in or out until the beam points straight ahead.

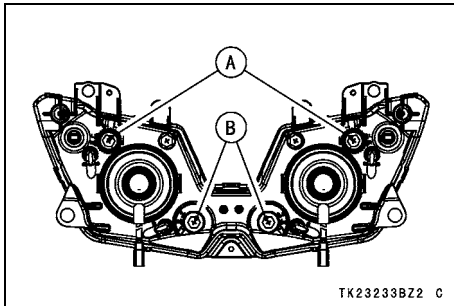

TK23233BZ2 C

- A. Horizontal Adjusters
B. Vertical Adjusters

Vertical Adjustment

The headlight beam is adjustable vertically. If adjusted too low, neither low nor high beam will illuminate the road far enough ahead. If adjusted too high, the high beam will fail to illuminate the road close ahead, and the low beam will blind oncoming drivers.

- Turn the vertical adjuster in or out to adjust the headlight vertically.

NOTE

- *On high beam, the brightest points should be slightly below horizontal. The proper angle is 0.4 degrees below horizontal. This is a 50 mm (2.0 in.) drop at 7.6 m (25 ft) measured from the center of the headlight, with the motorcycle on its wheels and the rider seated.*

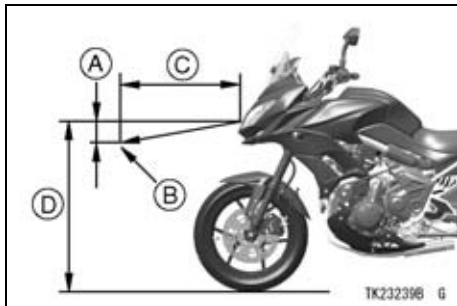

- A. 50 mm (2.0 in.)
- B. Center of Brightest Spot
- C. 7.6 m (25 ft)
- D. Height of Headlight Center

Fuses

Fuses are arranged in the fuse boxes located under the seat. The main fuse is located behind the starter relay cover. If a fuse fails during operation,

inspect the electrical system to determine the cause, and then replace it with a new fuse of proper amperage.

If the fuse fails repeatedly, there is something wrong with the electrical system. Have the motorcycle checked by an authorized Kawasaki dealer.

The main fuse removal should be done by an authorized Kawasaki dealer.

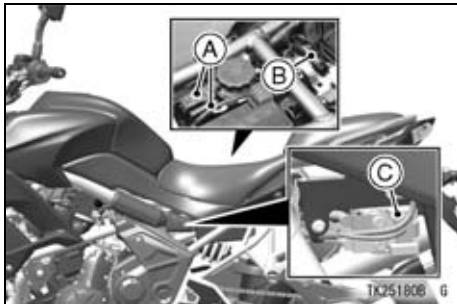

- A. Fuse Boxes**
- B. Fuse Box**
- C. Main Fuse**

- To access the main fuse, remove the left frame cover and starter relay cover.
- Remove the bolts, collar and washer.
- Pull the left frame cover outward to clear the projections from the frame.

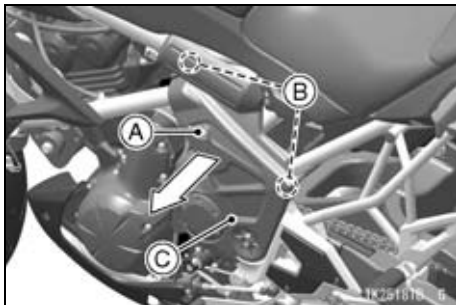

- A. Bolt, Collar and Washer**
- B. Projections**
- C. Left Frame Cover**

- Remove the bolt.
- Pull the starter relay cover outward to clear the tab from the rear fender.

146 MAINTENANCE AND ADJUSTMENT

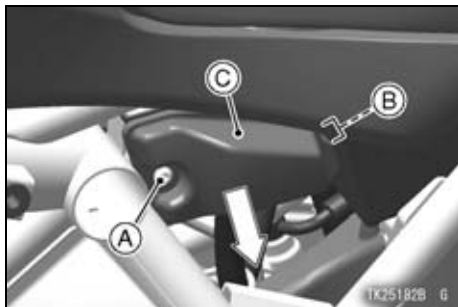

- A. Bolt
- B. Tab
- C. Starter Relay Cover

- Disconnect the starter relay connector.

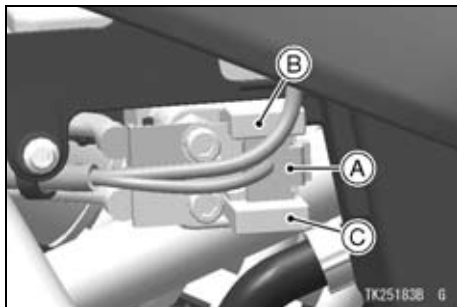

- A. Starter Relay Connector
- B. Main Fuse 30 A
- C. Spare Fuse 30 A

- Install the starter relay cover and left frame cover as follows.
- Connect the starter relay connector.
- Insert the tab on the starter relay cover into the gap between the rear fender and connector.
- Take care not to pinch the fuel pump lead.
- Tighten the bolt.

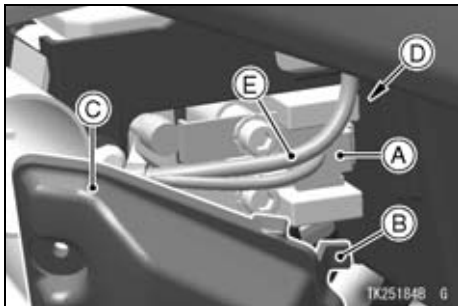

- A. Starter Relay Connector
- B. Tab
- C. Starter Relay Cover
- D. Gap
- E. Fuel Pump Lead

- Fit the tab on the frame cover to the slot on the frame.
- Insert the projections on the frame cover to the grommets on the frame.

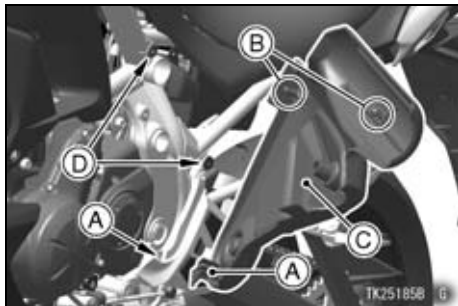

- A. Slot and Tab
- B. Projections
- C. Left Frame Cover
- D. Grommets

- Install the washer and collar.
- Tighten the bolt securely.

WARNING

Substituting fuses can cause wiring to overheat, catch fire and/or fail. Do not use any substitute for the standard fuse. Replace the blown fuse with a new one of the correct capacity, as specified on the fuse boxes and main fuse.

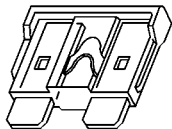

A

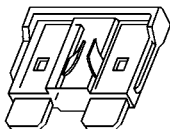

B

TK25007BZ2 C

- A. Normal
B. Failed

General Lubrication

Lubricate the points shown below, with either engine oil or regular grease, in accordance with the Periodic Maintenance Chart or whenever the vehicle has been operated under wet or rainy conditions.

Before lubricating each part, clean off any rusty spots with rust remover and wipe off any grease, oil, dirt, or grime.

Apply motor oil to the following pivots

- Side Stand
- Clutch Lever
- Front Brake Lever
- Rear Brake Pedal

Lubricate the following cables with a pressure cable luber

- (K) Clutch Inner Cable
- (K) Throttle Inner Cables

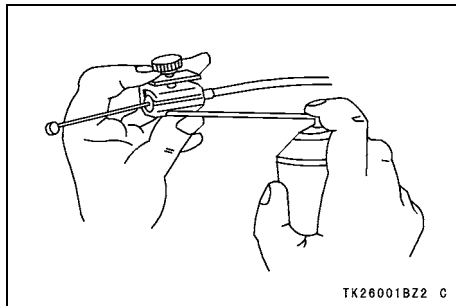

Apply grease to the following points

- **(K)** Clutch Inner Cable Upper End
- **(K)** Throttle Inner Cable Upper Ends

(K): Should be serviced by an authorized Kawasaki dealer.

NOTE

- *After connecting the cables, adjust them.*

Cleaning

General Precautions

Frequent and proper care of your vehicle will enhance its appearance, optimize overall performance, and extend its useful life. Covering your vehicle with a high quality, breathable vehicle cover will help protect its finish from harmful UV rays, pollutants, and reduce the amount of dust reaching its surfaces.

 **WARNING**

Build-up of debris or flammable material in and around the vehicle chassis, engine, and exhaust can cause mechanical problems and increase the risk of fire. When operating the vehicle in conditions that allow debris or flammable material to collect in and around the vehicle, inspect the engine, electrical component and exhaust areas frequently. If debris or flammable materials have collected, park the vehicle outside and stop the engine. Allow the engine to cool, then remove any collected debris. Do not park or store the vehicle in an enclosed space prior to inspecting for build-up of debris or flammable materials.

- Be sure the engine and exhaust are cool before washing.
- When washing the vehicle, always use a mild neutral detergent and water.
- Avoid applying all harsh chemicals, solvents, degreaser, oil remover, electrical contact cleaner, and household cleaning products such as ammonia-based window cleaners. They will damage or deteriorate painted parts, plastic parts, rubber parts and other synthetic parts including covers and headlight lens.
- Avoid applying degreaser to seals, brake pads, and tires.
- Gasoline, brake fluid, and coolant will damage the finish of painted and plastic surfaces: wash them off immediately.
- Avoid wire brushes, steel wool, and all other abrasive pads or brushes.

- Take care when washing the headlight lens and other plastic parts as they can easily be scratched.

NOTE

- *After riding in an area where the roads are salted or near the ocean, immediately wash your vehicle with cold water. Do not use warm water as it accelerates the chemical reaction of the salt. After drying, apply a corrosion protection spray on all metal and chrome surfaces to prevent corrosion.*
- *Condensation may form on the inside of the headlight lens after riding in the rain, washing the vehicle or in humid weather. To remove the moisture, start the engine and turn on the headlight. Gradually the condensation on the inside of the lens will clear off.*

Radiator

Clean off any obstructions with a stream of low-pressure water.

NOTICE

Using high-pressure water, as from a car wash facility, could damage the radiator fins and impair the radiator's effectiveness. Do not obstruct or deflect airflow through the radiator by installing unauthorized accessories in front of the radiator or behind the cooling fan. Interference with the radiator airflow can lead to overheating and consequent engine damage.

Matte Paint Parts

- When washing the vehicle, always use a mild neutral detergent and water, or cleaners for matte paint.

152 MAINTENANCE AND ADJUSTMENT

- The matte paint effect may be lost when the paint is excessively rubbed.
- If any doubt, consult an authorized Kawasaki dealer.

Plastic Parts

After washing, use a soft cloth to gently dry plastic parts. When dry, treat the headlight lens and other non painted plastic parts with an approved plastic cleaner/polisher product.

NOTICE

Plastic parts may deteriorate and break if they come in contact with chemical substances or household cleaning products such as gasoline, brake fluid, window cleaners, thread-locking agents, or other harsh chemicals. If a plastic part comes in contact with any harsh chemical substance, wash it off immediately with water and a mild neutral detergent, and then inspect for damage. Avoid using abrasive pads or brushes to clean plastic parts, as they will damage the part's finish.

Chrome and Aluminum

Chrome and uncoated aluminum parts can be treated with a chrome/aluminum polish. Coated aluminum

should be washed with a mild neutral detergent and finished with a spray polish. Aluminum wheels, both painted and unpainted can be cleaned with special non-acid based wheel spray cleaners.

Leather, Vinyl, and Rubber

If your vehicle has leather accessories, special care must be taken. Use a leather cleaner/treatment to clean and care for leather accessories. Washing leather parts with detergent and water will damage them, shortening their life.

Vinyl parts should be washed with the rest of the vehicle, then treated with a vinyl treatment.

The sidewalls of tires and other rubber components should be treated with a rubber protectant to help prolong their useful life.

Where to be Careful

Avoid spraying water with any great force near the following places.

- Disc brake master cylinder and caliper.
- Under the seat - if water gets into the fuse box or battery, it can ground out the spark. When this happens the vehicle will not operate properly and the affected parts must be wiped dry.

NOTICE

Coin operated, high pressure spray washers are not recommended. Water may be forced into bearings and other components causing eventual failure from rust and corrosion. Some soaps are highly alkaline and may leave a residue or cause spotting.

NOTE

- *Abrasive cleanser or high pressure washer will damage the surface finish on the bodywork.*

Washing Your Vehicle

- Before washing, precautions must be taken to keep water off the following parts.

Muffler rear opening - cover with a plastic bag.

Ignition switch - cover the keyhole with tape.

- Rinse your vehicle with cold water from a garden hose to remove any loose dirt.
- Mix a mild neutral detergent (designed for motorcycles or automobiles) and water in a bucket. Use a soft cloth or sponge to wash your vehicle.
- After washing, rinse your vehicle thoroughly with clean water to remove any residue (residue from the detergent can damage parts of your vehicle).
- Remove the plastic bag and tape.
- Use a soft cloth to dry your vehicle. As you dry, inspect your vehicle for chips and scratches. Do not let the water air dry as this can damage the painted surfaces.

- Carefully ride your vehicle at a slow speed and apply the brakes several times. This helps dry the brakes and restores them to normal operating performance.

Storage

Whenever your motorcycle will not be in use for a long period, proper storage is essential.

It consists of checking and replacing missing or worn parts; lubricating parts to ensure that they do not corrode and, in general, preparing the motorcycle so that when the time comes to use it again, it will be in top condition.

See your authorized Kawasaki dealer for this service or do the following.

Preparation for Storage

Make sure the area is well ventilated and free from any source of flame.

DANGER

Exhaust gas contains carbon monoxide, a colorless, odorless poisonous gas. Inhaling carbon monoxide can cause serious brain injury or death. DO NOT run the engine in enclosed areas. Operate only in a well-ventilated area.

 **WARNING**

Gasoline is extremely flammable and can be explosive under certain conditions, creating the potential for serious burns.

- Turn the ignition key off.
- Do not smoke.
- Make sure the area is well ventilated and free from any source of flame or sparks; this includes any appliance with a pilot light.

 **WARNING**

Gasoline is a toxic substance. Dispose of gasoline properly. Contact your local authorities for approved disposal methods.

- Clean the entire vehicle thoroughly.
- Run the engine for about five minutes to warm the oil, shut it off, and drain the engine oil. (see Engine Oil section in the MAINTENANCE AND ADJUSTMENT chapter)

 **WARNING**

Engine oil is a toxic substance. Dispose of used oil properly. Contact your local authorities for approved disposal methods or possible recycling.

- Put in fresh engine oil.
- Empty the fuel from the fuel tank using a pump or syphon.
- Remove the spark plugs and add fogging oil into the combustion chambers. If the spark plugs cannot be removed, take the motorcycle to an authorized Kawasaki dealer.
- Set the motorcycle on a stand so that both wheels are raised off the ground. (If this cannot be done, put boards under the front and rear wheels to keep dampness away from the tire rubber.)
- Spray oil on all unpainted metal surfaces to prevent rusting. Avoid getting oil on rubber parts or in the brakes.
- Lubricate the drive chain and all the cables.
- Remove the battery, and store it where it will not be exposed to direct sunlight, moisture, or freezing temperatures. During storage it should be given a slow charge (one ampere or less) about once a month. Keep the battery well charged especially during cold weather.
- Tie plastic bag over the muffler to prevent moisture from entering.
- Put a cover over the motorcycle to keep dust and dirt from collecting on it.

Preparation after Storage

- Remove the plastic bag from the muffler.
- Charge the battery if necessary and install the battery in the motorcycle.
- Fill the fuel tank with fresh fuel.
- Check all the points listed in the Daily Checks section.
- Lubricate the pivots, bolts, and nuts.

Troubleshooting Guide

If a Problem Occurs

Performing daily checks and periodic maintenance prevents unexpected troubles from occurring. In case of a breakdown, take emergency measures and contact your Kawasaki dealer to request repair. For safety, inspection and maintenance should be done within your knowledge and ability. If you are not confident in completing an inspection or maintenance, ask an authorized Kawasaki dealer to do the work.

 **WARNING**

- When carrying out an inspection, follow the precautions below.
- Secure a place where you can work in safety without obstructing traffic around you. Do not carry out any inspection unless it is safe.
- Support the motorcycle on a firm, level surface with the stand.
- The engine and muffler will become hot during operation. To avoid burns etc., do not touch the hot engine or muffler just after the engine has stopped.
- Exhaust gas contains harmful substances such as carbon monoxide. Do not run the engine in an enclosed garage or poorly ventilated area.
- Wait until the engine cools down before carrying out inspection and maintenance or replenishing fuel. Make sure the area is well ventilated and free from any source of flame or sparks. Do not place any appliance with a pilot light nearby.
- If a test ride is needed, ride in a safe area and pay close attention to traffic around you.

When any warning indicators go on or blink, have the motorcycle inspected by an authorized Kawasaki dealer immediately.



If the Engine Does Not Start

When the engine turns over but the engine does not start, inspect as follows.

- Check the fuel level in the fuel tank. If only a small quantity of fuel remains in the bottom, replenish the fuel tank. (Fuel in the tank cannot be completely consumed.)
- Leaving the motorcycle unused for a long time may cause fuel in the tank to deteriorate. In that case, ask an authorized Kawasaki dealer for inspection.
- When the engine warning indicator on the meter goes on and stays on, there may be a problem with the fuel injection system. Ask an authorized Kawasaki dealer for inspection and maintenance.
- The motorcycle is equipped with a vehicle-down sensor which stops the engine automatically when the motorcycle falls down. When the starter button is pressed after the motorcycle has fallen down, the engine warning indicator blinks and the engine does not start. To start the engine, switch the ignition key to the “OFF” position and then back to the “ON” position.

If the engine will not start after completing the above inspection and maintenance, there may be something wrong with another system such as the ignition system. Ask an authorized Kawasaki dealer for inspection and maintenance.

When the starter motor does not rotate, inspect as follows.

- Check the position of the engine stop switch. Push the engine stop switch in the  position if it is in the  position.
- Make sure that the gear position is in the neutral position. If not, shift the transmission into neutral.

- Inspect the fuse condition. If any fuse has blown, replace it with a new one of the same amperage.

 **WARNING**

Substituting fuses can cause wiring to overheat, catch fire and/or fail. Use only standard fuses of the correct capacity and specifications.

- Check the battery cable connections etc. (see page 142). If necessary, tighten the connecting bolts to securely connect them.
- In case of slow blinking of the turn signal lights, low volume of the horn sound, or when you press the starter button and hear a click but the starter motor does not rotate, battery charging status is not good. Refresh the battery's charge (see page 141) and check if the starter motor rotates.
- Even after a refresh charge, if the starter motor stops rotating the engine properly, the battery may have deteriorated. Have the battery inspected by an authorized Kawasaki dealer.

If the starter motor will not start after completing the above inspection and maintenance, there may be something wrong with another part such as the starter motor. Ask an authorized Kawasaki dealer for inspection and maintenance.

If the Engine Stalls or Runs Poorly

- Check the fuel level in the fuel tank. If only a small quantity of fuel remains, replenish the fuel tank. (Fuel in the tank cannot be completely consumed.)
- Raise the side stand fully up before starting the engine. (If you try to move off with the side stand is still down, the engine will stop.)
- Make sure that correct fuel is used. If not, replace the fuel the correct type (see page 62).
- Due to too much play in the clutch lever, the clutch may not disengage. If there is any problem, adjust the clutch lever free play correctly.
- In case of slow blinking of the turn signal lights, low volume of the horn sound, or when you press the starter button and hear a click but the starter motor does not rotate, the battery is discharged. Check the connections of the battery terminals for looseness (see page 142). If necessary, tighten the bolts to remove the looseness. If the above methods cannot solve the problems, ask an authorized Kawasaki dealer for inspection and maintenance.
- If the warning indicator goes on and coolant temperature warning indicator is displayed, the engine may have overheated. Check the coolant level in the reserve tank after the engine cools down. If the coolant quantity is less than the lower level, replenish the coolant or soft water up to the upper level (see page 106). Ask an authorized Kawasaki dealer to identify the cause of the overheat immediately.

- When the engine warning indicator on the meter goes on and stays on, there is something wrong with the fuel injection system. Ask an authorized Kawasaki dealer for inspection and maintenance.

If the engine stalls after completing the above inspection and maintenance, there may be something wrong with other system. Ask an authorized Kawasaki dealer for inspection and maintenance.

Your Warranty/Owner Satisfaction

Welcome to the Kawasaki family!

Congratulations on buying your Kawasaki vehicle. You've chosen a great, high-quality product with state-of-the-art features and built to Kawasaki's high standards. Your satisfaction is important to your authorized Kawasaki dealer and to Kawasaki Motors Corp., U.S.A. Here is some important information regarding your vehicle's limited warranty.

Frequently Asked Questions

What is a Limited Warranty?

The most important thing to know about your warranty is that it protects you from manufacturing defects in material or workmanship during the warranty period. You can find the warranty period in the Kawasaki Limited Warranty Certificate your Kawasaki dealer provided to you at the time of sale. The warranty does not

cover the cost of regularly-scheduled maintenance. The warranty also does not apply to the normal wear of items such as tires, brake pads, transmission drive belts, chains, sprockets, etc.

What is the Good Times Protection Plan?

Much of the warranty coverage offered by the limited warranty can be extended by purchasing Kawasaki's Good Time™ Protection Plan (GTPP). See your Kawasaki dealer or go to Kawasaki.com for more information if you don't already have the GTPP.

What Am I Responsible For?

You are responsible for maintaining your vehicle according to the maintenance schedule shown in this owner's manual.

You are responsible for notifying your dealer immediately if there is a problem, and you, as the owner, will need to authorize the dealer to inspect the unit.

You will be responsible for paying for routine maintenance, including the first scheduled service. You can have the required servicing done by your Kawasaki dealer (recommended) or an equally-qualified service facility. You can also do your own maintenance work if you have the proper tools, service references, and mechanical skills. However, if a failure is found to be caused by improper servicing, it would not be covered by the limited warranty.

You may purchase a Kawasaki Service Manual and any necessary special tools directly from your Kawasaki dealer.

You will be responsible for paying for repairs needed because of an accident, to replace worn parts such as tires, chains, brakes, and for repairs needed because of a lack of maintenance, misuse or racing.

Whether you do it yourself or take your vehicle to a Kawasaki dealer, be sure to record your service in the Maintenance Record section of this Owner's Manual. Keep all receipts for the service and/or items necessary to perform the maintenance so that in the event of a failure you can document the service history.

What Are The Dealership's Responsibilities?

Your Kawasaki dealer offers a wide range of services, parts, accessories, and information on your product and on Kawasaki.

Each dealer is independently owned and operated and is responsible for the dealership's operations, its repair, warranty, and service work, and its personnel.

Your dealer is responsible for completing the set up and pre-delivery service of your new Kawasaki vehicle. The dealership should also explain its operation, maintenance, and warranty provisions so you understand them at the time of purchase or at any other time you have questions.

The dealership is responsible for inspecting your Kawasaki vehicle if there is a failure, investigating the cause of the problem, and getting any needed authorization from Kawasaki if the repair is one that will be covered by the limited warranty. The dealership will also file all necessary paperwork. The dealership is responsible for correctly completing any necessary repairs, whether they are covered by the limited warranty or not.

How Do I Get Warranty Service?

If there is a problem with your vehicle within the limited warranty period, you will need to schedule a service appointment and provide any maintenance records to an authorized Kawasaki dealer for inspection and diagnosis. You can go to any Kawasaki dealer for warranty repairs. Your Kawasaki dealer will inspect your vehicle and give you the results of the inspection. The dealer will perform the repairs at no cost to you if it is determined that the problem is covered by the warranty.

Kawasaki will work with your dealer to resolve any warranty issues. No authorization for warranty work can be given until your vehicle has been inspected by a Kawasaki dealer.

What if I am not Satisfied With My Warranty Service?

If you aren't satisfied with your dealership's repair work or operations, it is best to discuss the situation with the appropriate dealership manager. If you have already done this, then contact the dealership's owner or general manager to request a review of the issue.

If you are unable to resolve a problem after consulting with the dealership management and need further assistance, contact Kawasaki Motors Corp., U.S.A. at the address below. Please be certain to provide the model, vehicle identification number (VIN), mileage or hours of use, accessories, dates that events occurred and what action has been taken by both you and your dealer. Include the name and address of the dealership. To assist us in resolving your inquiry, please include copies of related receipts and any other pertinent information including the name of the dealership personnel with whom you have been working. Upon receipt of your correspondence, Kawasaki Motors Corp., U.S.A. will contact the dealership and work with it in resolving your problem.

Want to Contact Kawasaki?

This owner's manual should answer most of your questions about your Kawasaki. Your Kawasaki dealer should either be able to answer any other questions you might have immediately or be able to find the answer for you.

Please send your correspondence to:

Consumer Services
Kawasaki Motors Corp., U.S.A.
P.O. Box 25252
Santa Ana, CA 92799-5252
(949) 460-5688

Reporting Safety Defects

(For Products Sold in the United States of America, District of Columbia, and U.S. Territories Only)

If you believe that your vehicle has a defect which could cause a crash or could cause injury or death, you should immediately inform the National Highway Traffic Safety Administration (NHTSA) in addition to notifying Kawasaki Motors Corporation, U.S.A.

If NHTSA receives similar complaints, it may open an investigation, and if it finds that a safety defect exists in a group of vehicles, it may order a recall and remedy campaign. However, NHTSA cannot become involved in individual problems between you, your dealer, or Kawasaki Motors Corporation, U.S.A.

To contact NHTSA, you may either call the Auto Safety Hotline toll-free at 1-800-424-9393 (or 366-0123 in Washington, D.C. area) or write to: NHTSA, U.S. Department of Transportation, Washington, D.C. 20590. You can also obtain other information about motor vehicle safety from the Hotline.

Environmental Protection

To help preserve the environment, properly discard used batteries, tires, oils and fluids, or other vehicle components that you might dispose of in the future. Consult your authorized Kawasaki dealer or local environmental waste agency for their proper disposal procedure. This also applies to disposal of the entire vehicle at the end of its life.

MAINTENANCE RECORD

Owner Name.....

Address

Phone Number

Engine Number

Vehicle Number.....

Key Code

Selling Dealer Name

Phone Number

Warranty Start Date

Note: Keep this information and a spare key in a secure location.

Date	Odometer Reading	Maintenance Performed	Dealer Name	Dealer Address

KLE650FG



Kawasaki Heavy Industries, Ltd. Motorcycle & Engine Company

Printed in Thailand

GB